

2016 TOWING CATALOG









TOWING PRODUCTS

SAFE. RELIABLE. STYLISH.

Important: Review your vehicle owner's manual before purchasing a towing system. The manual has helpful information about the vehicle's limitations and capabilities.



VEHICLE/TRAILER CHART WEIGHT & CLASS RATING	CLASS I	CLASS III/IV
		
 COMPACT CARS/MID-SIZE CARS	CLASS I 1.25" RECEIVER UP TO 2,000 LBS.	
 SMALL PICKUPS/MINIVANS/CUV	CLASS I 1.25" RECEIVER UP TO 2,000 LBS.	CLASS III 2" RECEIVER 3,500 - 5,000 LBS.
 MID-SIZE SUV/PICKUPS	CLASS I 1.25" RECEIVER UP TO 2,000 LBS.	CLASS III 2" RECEIVER 3,500 - 5,000 LBS.
 FULL-SIZE PICKUPS/VANS/SUV		CLASS III/IV 2" RECEIVER 3,500 - 10,000 LBS.

Disclaimer: Always adhere to a vehicle's manufacturer recommended towing specifications. Improper use or installation of these products will void warranty and may result in vehicle damage, personal injury or injury to others. Professional installation of Westin towing products is recommended.

Note: Refer to owner's manual for vehicle's maximum towing capacity

THE STRENGTH TO TOW WHEREVER YOU WANT TO GO

TABLE OF CONTENTS

Application Chart

Chart.....pg 04

Receiver Hitches

Class I.....pg 12

Class III/IV.....pg 13

Receiver Hitch Application.....pg 14

Electrical

T-Connectors.....pg 16

T-Connector Applications.....pg 18

Tail Light Converters.....pg 25

Connectors.....pg 26

Adapters.....pg 30

Brake Products

Brake Controllers.....pg 32

Wiring Harness.....pg 34

Breakaway Kits.....pg 35

Wiring Harness Applications.....pg 36

Accessories

Tow Accessories.....pg 38

Retail

Display.....pg 42



RECEIVER HITCHES

CLASS I
(200/2,000 LBS TW/GTW)

CLASS III / IV
(350-600/3,500-6,000 LBS TW/GTW)

MODEL/STYLE	YEAR	HITCH PART#	FOOTNOTE	TUBE STYLE	WC (LBS)	INSTALL TIME (MIN)	HITCH PART#	FOOTNOTE	WC (LBS)	WD (LBS)	INSTALL TIME (MIN)	TUBE STYLE
BUICK												
Enclave	08-16	-		-	-	-	65-1085	1,4,7,9	500/5,000	600/6,000	60	Round
CHEVROLET												
Colorado	04-12	-		-	-	-	65-1145	1	400/4,000	600/6,000	60	Round
Colorado	15-16	-		-	-	-	65-1535		500/5,000	800/8,000	60	Round
Equinox	04-16	-		-	-	-	65-1075	1,4	350/3,500	400/4,000	45	Round
Express	96-16	-		-	-	-	65-1135		600/6,000	1,000/10,000	30	Square
Silverado 1500	99-13	-		-	-	-	65-1005	1,4	600/6,000	1,000/10,000	45	Round
Silverado 1500	14-16	-		-	-	-	65-1475		600/6,000	1,000/10,000	45	Round
Silverado 2500LD	99-05	-		-	-	-	65-1005	1,4	600/6,000	1,000/10,000	45	Round
Terrain	10-16	-		-	-	-	65-1075	1,4	350/3,500	400/4,000	45	Round
Traverse	09-16	-		-	-	-	65-1075	1,4,7,9	500/5,000	600/6,000	60	Round
CHRYSLER												
Town & Country	08-16	-		-	-	-	65-1175	7	350/3,500	500/5,000	90	Round
DODGE												
Caravan	08-16	-		-	-	-	65-1175	7	350/3,500	600/6,000	90	Round
Durango	11-16	-		-	-	-	65-1055	1,4	500/5,000	800/8,000	45	Round
Journey	09-16	-		-	-	-	65-1275		350/3,500	-	60	Round

T-CONNECTOR FOOTNOTE:

	A1: Tail light converter not included	A2: Fit vehicle W/Factory 7-Way	A3: Tail light converter included	A4: 4Dr Sedan only	A5: Excl. Plug-In Models	A6: SE Models Only	A7: Fits All Models	A8: Vehicle with Factory Tow	A9: Vue Red Line	
RECEIVER HITCH	1	Will not fit vehicle with factory installed hitch receiver				8	Trimming of exhaust heat shield is required for installation			
	2	Trimming of rear bumper fascia may be required for sport models				9	Factory bumper hitch cover can be re-installed after installation			
	3	Trimming of rear bumper insert and rear splash shields may be required for installation				10	Excludes 97/98 F150/250LD			
	4	Requires OEM style rear bumper and mounting bracket				11	Will not fit vehicles built on or before Nov. 2002			
	5	Excludes fitment on X-Runner model				12	Trimming required			
	6	Drilling required for installation				13	Receiver only, no cross tube			
	7	Exhaust system needs to be temporarily lowered for installation				14	Exclude Sedan & Sport Edition			

ELECTRICAL																
T-CONNECTOR								BRAKE CONTROL HARNESS					TAIL LIGHT CONVERTER			
OUTPUT	YEAR	ELECTRICAL SYSTEM TYPE	WIRING LOCATION	PART #	FOOTNOTE	INSTALL TIME (MIN)	AMP	YEAR	PART #	WIRING LOC	INSTALL TIME (MIN)	NOTES	OUTPUT	STANDARD PART	CIRCUIT PROTECTION	
BUICK (Continued)																
4-Flat	09-12	2W	A,B	65-60067	A1	10	11.2	08-12	65-75289	A	5	W/Factory Towing Pkg	-	-	-	
4-Flat	13-16	3W	A,B	65-60016	A3	45	15.4									
4-Flat	04-16	2W	F	65-60012	A1, A2	5	15.4									
CHEVROLET (Continued)																
4-Flat	04-12	3W	E	65-60022	A3	10	11.2	-	-	-	-		-	-	-	
4-Flat	04-12	2W	G	65-60013	A1, A2	5	15.4									
4-Flat	14-16	2W	F	65-60012	A1, A2	5	15.4	-	-	-	-		-	-	-	
4-Flat	14-16	2W	G	65-60013	A1, A2	5	15.4									
4-Flat	05-06	3W	C	65-60037	A3	10	11.2	-	-	-	-		-	-	-	
4-Flat	07-09	2W	C	65-60038	A1	10	11.2									
4-Flat	10-16	2W	A,B	65-60072	A1	15	15.4									
4-Flat	96-99	3W	C,D	65-60042	A3	10	11.2	-	-	-	-		-	-	-	
4-Flat	00-02	3W	C,D	65-60044	A3	10	11.2									
4-Flat	04-16	2W	C,D	65-60045	A1	40	15.4									
4-Flat	07-13	2W	G	65-60012	A1, A2	5	15.4	99-02	65-75283	C	5	Light Duty	-	-	-	
4-Flat	07-13	2W	G	65-60013	A1, A2	5	15.4	01-02	65-75283	C	5	Heavy Duty				
								03-06	65-75284	C	5					
								2007	65-75284	C	5	Classic Only				
4-Flat	14-16	2W	G	65-60012	A1, A2	5	15.4	14-16	65-75296	A	5		-	-	-	
4-Flat	14-16	2W	G	65-60013	A1, A2	5	15.4									
4-Flat	99-05	2W	G	65-60013	A1, A2	5	15.4	99-02	65-75283	C	5		-	-	-	
								03-05	65-75284	C	5		-	-	-	
4-Flat	10-16	2W	A,B	65-60072	A1	15	15.4	-	-	-	-		-	-	-	
4-Flat	09-16	2W	G	65-60013	A1, A2	5	15.4	-	-	-	-		-	-	-	
4-Flat	09-12	2W	A,B	65-60067	A1	10	15.4									
CHRYSLER (Continued)																
4-Flat	08-15	2W	A,B	65-61028	A3	45	11.2	-	-	-	-		-	-	-	
4-Flat	11-16	3W	A,B	65-61029	A3	45	11.2									
DODGE (Continued)																
4-Flat	08-15	2W	A,B	65-61028	A3	45	11.2	-	-	-	-		-	-	-	
4-Flat	11-16	3W	A,B	65-61029	A3	45	11.2									
4-Flat	08-15	2W	A,B	65-61028	A3	45	11.2	11-13	65-75294	A	5		-	-	-	
4-Flat	09-15	2W	G	65-60013	A1, A2	5	15.4									
4-Flat	09-15	2W	F	65-60012	A1, A2	5	15.4									
4-Flat	2009	3W	C,D	65-61051	A3	45	11.2	-	-	-	-		-	-	-	
4-Flat	2010	2W	A,B	65-61052	A3, A16	10	15.4									
4-Flat	13-15	2W	A,B	65-61052	A3, A15	45	15.4									
4-Flat	11-15	2W	A,B	65-61053	A3, A16	45	11.2									
T-CONNECTOR FOOTNOTE:																
A10: Excl. Chrome 08-13		A11: Excl. Limited and RH Drive		A12: 6 Cyl. W/Factory Towing		A13: Fit SuperCrew Cab Only		A14: Excl. Cross Cabriolet		A15: Vehicle without LED Tailights (Std Bulbs)			A16: Vehicle with LED Tailights		A17: Hatchback Only	
WIRING LOCATIONS	A	Behind the driver's side tail light housing								LEGEND						
	B	Behind the passenger's side tail light housing								WC	Weight Capacity			ELECTRICAL SYSTEM TYPE		
	C	Behind the driver's side cargo area interior access panel								WD	Weight Distribution			2W	2-wire system	
	D	Behind the passenger's side cargo interior access panel								ST	Stop, Tail			3W	3-wire system	
	E	Under the vehicle, behind the bumper fascia on the driver's side								STT	Stop, Tail, Turn			PWM	ST or STT	
	F	Under the vehicle, behind the bumper fascia near the center of the vehicle														
G	Under the vehicle, behind the bumper fascia on the passenger's side															

RECEIVER HITCHES

**CLASS I
(200/2,000 LBS TW/GTW)**

**CLASS III / IV
(350-600/3,500-6,000 LBS TW/GTW)**

MODEL/STYLE	YEAR	HITCH PART#	FOOTNOTE	TUBE STYLE	WC (LBS)	INSTALL TIME (MIN)	HITCH PART#	FOOTNOTE	WC (LBS)	WD (LBS)	INSTALL TIME (MIN)	TUBE STYLE
DODGE												
Ram 1500	03-16	-		-	-	-	65-1015	1,4,11,13	600/6,000	1,000/10,000	60	-
FORD												
Edge	07-14	-		-	-	-	65-1105	1,2,4,6,7,8	400/4,000	600/6,000	90	Round
Escape	05-12	-		-	-	-	65-1095	1,4	350/3,500	500/5,000	90	Round
Escape	13-16	65-1265		Round	200/2,000	60						
Explorer	11-16	-		-	-	-	65-1235	1,4,7	500/6,000	600/6,000	60	Round
E-150	00-14	-		-	-	-	65-1165		600/6,000	1,000/10,000	30	Square
E-250	00-14	-		-	-	-	65-1165		600/6,000	1,000/10,000	30	Square
E-350	00-14	-		-	-	-	65-1165		600/6,000	1,000/10,000	30	Square
F-150	06-08	-		-	-	-	65-1485	1	600/6,000	1,000/10,000	30	-
F-150	09-14	-		-	-	-	65-1025	1,4	600/6,000	1,000/10,000	60	Square
F-150	15-16	-		-	-	-	65-1515		600/6,000	1,000/10,000	60	Round
Focus	12-16	65-1205	7,14	Round	200/2,000	45	-	-	-	-	-	-
Ranger	83-11						65-1065	1,4,6	400/4,000	600/6,000	45	Square
GMC												
Acadia	07-16	-		-	-	-	65-1085	1,4,7,9	500/5,000	600/6,000	60	Round

T-CONNECTOR FOOTNOTE:

A1: Tail light converter not included **A2:** Fit vehicle W/Factory 7-Way **A3:** Tail light converter included **A4:** 4Dr Sedan only **A5:** Excl. Plug-In Models **A6:** SE Models Only **A7:** Fits All Models **A8:** Vehicle with Factory Tow **A9:** Vue Red Line

RECEIVER HITCH	1	2	3	4	5	6	7	8	9	10	11	12	13	14
	Will not fit vehicle with factory installed hitch receiver	Trimming of rear bumper fascia may be required for sport models	Trimming of rear bumper insert and rear splash shields may be required for installation	Requires OEM style rear bumper and mounting bracket	Excludes fitment on X-Runner model	Drilling required for installation	Exhaust system needs to be temporarily lowered for installation	Trimming of exhaust heat shield is required for installation	Factory bumper hitch cover can be re-installed after installation	Excludes 97/98 F150/250LD	Will not fit vehicles built on or before Nov. 2002	Trimming required	Receiver only, no cross tube	Exclude Sedan & Sport Edition

ELECTRICAL															
T-CONNECTOR								BRAKE CONTROL HARNESS					TAIL LIGHT CONVERTER		
OUTPUT	YEAR	ELECTRICAL SYSTEM TYPE	WIRING LOCATION	PART #	FOOTNOTE	INSTALL TIME (MIN)	AMP	YEAR	PART #	WIRING LOC	INSTALL TIME (MIN)	NOTES	OUTPUT	STANDARD PART	CIRCUIT PROTECTION
DODGE (Continued)															
4-Flat	00-08	2W	G	65-61003	A1	5	15.4	03-09	65-15281	A	10		-	-	-
4-Flat	02-05	3W	A,B	65-61004	A3	10	11.2	10-12	65-75293	C	10				
4-Flat	09-15	2W	G	65-60012	A1, A2	5	15.4								
4-Flat	09-15	2W	G	65-60013	A1, A2	5	15.4								
FORD (Continued)															
4-Flat	07-10	2W	A,B	65-62055	A3	45	11.2	-	-	-	-		-	-	-
4-Flat	11-14	2W	A,B	65-62057	A3	45	11.2								
4-Flat	05-07	3W	A,B	65-62045	A3	45	11.2	-	-	-	-		4-Flat	-	65-75390
4-Flat	08-12	2W	A,B	65-62055	A3	45	11.2								
4-Flat	13-16	3W	A,B	65-62076	A3	45	11.2	-	-	-	-		-	-	-
4-Flat	07-15	2W	G	65-60012	A1, A2	5	15.4	11-16	65-75280	B	5	W/Factory Tow Pkg			
4-Flat	00-15	2W	F	65-60013	A1, A2	5	15.4								
4-Flat	95-03	2W	A,B	65-62004	A1	10	15.4	00-08	65-75280	B	5				
4-Flat	04-14	2W	A,B	65-62016	A3	45	15.4	09-14	65-75290	B	5				
4-Flat	95-03	2W	A,B	65-62004	A1	10	15.4	00-08	65-75280	B	5				
4-Flat	04-14	2W	A,B	65-62016	A3	45	15.4	09-14	65-75290	B	5				
4-Flat	95-03	2W	A,B	65-62004	A1	10	15.4	00-08	65-75280	B	5		-	-	-
4-Flat	04-14	2W	A,B	65-62016	A3	45	15.4	09-14	65-75290	B	5				
4-Flat	97-13	2W	F	65-60012	A1, A2	5	15.4	04-08	65-75280	B	5	Excl. Heritage Edition	-	-	-
4-Flat	00-15	2W	G	65-60012	A1, A2, A13	5	15.4	00-08	65-75280	B	5	SuperCrew			
4-Flat	97-13	2W	G	65-60013	A1, A2	5	15.4	2004	65-75280	B	5	Includes Heritage Edition			
4-Flat	00-15	2W	G	65-60013	A1, A2, A13	5	15.4								
4-Flat	05-07	2W	G	65-62017	A1	5	15.4								
4-Flat	97-13	2W	F	65-60012	A1, A2	5	15.4	09-14	65-75292	H	15		-	-	-
4-Flat	00-15	2W	G	65-60012	A1, A2	5	15.4								
4-Flat	97-13	2W	G	65-60013	A1, A2	5	15.4								
4-Flat	00-15	2W	G	65-60013	A1, A2	5	15.4								
4-Flat	00-15	2W	G	65-60012	A1, A2	5	15.4	09-14	65-75292	H	15		-	-	-
4-Flat	12-16	3W	C,D	65-62080	A3, A4	45	11.2	-	-	-	-				
4-Flat	12-14	3W	A,B	65-62081	A3, A17	45	11.2								
4-Flat	83-85	2W	F	65-62002	A1	5	15.4	-	-	-	-		-	-	-
4-Flat	00-03	2W	A,B	65-62004	A1	10	15.4								
4-Flat	86-92	3W	E	65-62021	A1	10	15.4								
4-Flat	93-99	3W	E	65-62023	A3	10	11.2								
GMC (Continued)															
4-Flat	07-15	2W	F	65-60012	A1, A2	5	15.4	07-15	65-75289	A	5	W/Factory Tow Pkg			
4-Flat	07-15	2W	G	65-60013	A1, A2	5	15.4								
4-Flat	13-16	3W	A,B	65-60016	A3	45	15.4								
T-CONNECTOR FOOTNOTE:															
A10: Excl. Chrome 08-13		A11: Excl. Limited and RH Drive		A12: 6 Cyl. W/Factory Towing		A13: Fit SuperCrew Cab Only		A14: Excl. Cross Cabriolet		A15: Vehicle without LED Tailights (Std Bulbs)		A16: Vehicle with LED Tailights		A17: Hatchback Only	
WIRING LOCATIONS	A	Behind the driver's side tail light housing								LEGEND					
	B	Behind the passenger's side tail light housing								WC	Weight Capacity		ELECTRICAL SYSTEM TYPE		
	C	Behind the driver's side cargo area interior access panel								WD	Weight Distribution		2W	2-wire system	
	D	Behind the passenger's side cargo interior access panel								ST	Stop, Tail		3W	3-wire system	
	E	Under the vehicle, behind the bumper fascia on the driver's side								STT	Stop, Tail, Turn		PWM	ST or STT	
	F	Under the vehicle, behind the bumper fascia near the center of the vehicle													
G	Under the vehicle, behind the bumper fascia on the passenger's side														

RECEIVER HITCHES

CLASS I
(200/2,000 LBS TW/GTW)

CLASS III / IV
(350-600/3,500-6,000 LBS TW/GTW)

MODEL/STYLE	YEAR	HITCH PART#	FOOTNOTE	TUBE STYLE	WC (LBS)	INSTALL TIME (MIN)	HITCH PART#	FOOTNOTE	WC (LBS)	WD (LBS)	INSTALL TIME (MIN)	TUBE STYLE
GMC												
Canyon	04-12	-		-	-	-	65-1145	1	400/4,000	600/6,000	60	Round
Canyon	15-16	-		-	-	-	65-1535		500/5,000	800/8,000	30	Round
Savana	96-16	-		-	-	-	65-1135		600/6,000	1,000/10,000	30	Square
Sierra 1500	07-13	-		-	-	-	65-1005	1,4	600/6,000	1,000/10,000	45	Round
Sierra 1500	14-16	-		-	-	-	65-1475		600/6,000	1,000/10,000	45	Round
Sierra 2500LD	99-05	-		-	-	-	65-1005	1,4	600/6,000	1,000/10,000	45	Round
HONDA												
CRV	12-16	65-1385		Round	200/2,000	45	-	7	-	-	-	-
Odyssey	99-16	-		-	-	-	65-1305		350/3,500	-	60	Round
HYUNDAI												
Santa Fe	13-16	-		-	-	-	65-1405		350/3,500	-	60	Round
ISUZU												
I-Series	04-12	-		-	-	-	65-1145		400/4,000	600/6,000	60	Round
JEEP												
Compass	11-16	-		-	-	-	65-1445		500/5,000	600/6,000	-	-
Grand Cherokee	11-15	-		-	-	-	65-1055		500/5,000	800/8,000	30	Round
Liberty	08-13	-		-	-	-	65-1325		350/3,500	-	30	Round
Wrangler	07-16	-		-	-	-	65-1035	1,4,13	500/5,000	-	30	-
KIA												
Soul	14-16	65-1245	6	Round	200/2,000	45	-		-	-	-	-
Sorento	14-15	-		-	-	-	65-1405		500/5,000	600/6,000	60	-
LINCOLN												
MKX	07-14	-		-	-	-	65-1105	1,2,4,6,7,8	400/4,000	-	90	Round
NISSAN												
Frontier	05-16	-		-	-	-	65-1185		500/5,000	600/6,000	30	Square

T-CONNECTOR FOOTNOTE:

A1: Tail light converter not included **A2:** Fit vehicle W/Factory 7-Way **A3:** Tail light converter included **A4:** 4Dr Sedan only **A5:** Excl. Plug-In Models **A6:** SE Models Only **A7:** Fits All Models **A8:** Vehicle with Factory Tow **A9:** Vue Red Line

RECEIVER HITCH	1	2	3	4	5	6	7	8	9	10	11	12	13	14
	Will not fit vehicle with factory installed hitch receiver	Trimming of rear bumper fascia may be required for sport models	Trimming of rear bumper insert and rear splash shields may be required for installation	Requires OEM style rear bumper and mounting bracket	Excludes fitment on X-Runner model	Drilling required for installation	Exhaust system needs to be temporarily lowered for installation	Trimming of exhaust heat shield is required for installation	Factory bumper hitch cover can be re-installed after installation	Excludes 97/98 F150/250LD	Will not fit vehicles built on or before Nov. 2002	Trimming required	Receiver only, no cross tube	Exclude Sedan & Sport Edition

ELECTRICAL															
T-CONNECTOR								BRAKE CONTROL HARNESS					TAIL LIGHT CONVERTER		
OUTPUT	YEAR	ELECTRICAL SYSTEM TYPE	WIRING LOCATION	PART #	FOOTNOTE	INSTALL TIME (MIN)	AMP	YEAR	PART #	WIRING LOC	INSTALL TIME (MIN)	NOTES	OUTPUT	STANDARD PART	CIRCUIT PROTECTION
GMC (Continued)															
4-Flat	04-15	2W	F	65-60012	A1, A2	5	15.4	-	-	-	-		-	-	-
4-Flat	04-15	2W	G	65-60013	A1, A2	5	11.2								
4-Flat	04-15	2W	F	65-60012	A1, A2	5	11.2	-	-	-	-		-	-	-
4-Flat	04-15	2W	G	65-60013	A1, A2	5	15.4								
4-Flat	96-99	3W	C,D	65-60042	A3	10	11.2	-	-	-	-		-	-	-
4-Flat	00-02	3W	C,D	65-60044	A3	10	11.2								
4-Flat	04-16	2W	C,D	65-60045	A1	20	15.4								
4-Flat	07-13	2W	G	65-60012	A1, A2	5	15.4	99-02	65-75283	C	5	Light Duty	-	-	-
4-Flat	07-13	2W	G	65-60013	A1, A2	5	15.4	01-02	65-75283	C	5	Heavy Duty			
								2007	65-75284	C	5	Classic Only			
4-Flat	14-16	2W	G	65-60012	A1, A2	5	15.4	14-16	65-75296	A	5		-	-	-
4-Flat	14-16	2W	G	65-60013	A1, A2	5	15.4								
4-Flat	14-16	2W	G	65-60013	A1, A2	5	15.4	99-02	65-75283	C	5		-	-	-
								03-05	65-75284	C	5		-	-	-
HONDA (Continued)															
4-Flat	12-16	3W	C	65-63120	A3	45	11.2	-	-	-	-		-	-	-
4-Flat	95-04	3W	C	65-63101	A3	10	11.2	-	-	-	-		-	-	-
4-Flat	05-10	3W	D	65-63107	A3	20	11.2								
4-Flat	11-16	3W	C	65-63116	A3	30	11.2								
HYUNDAI (Continued)															
-	-	-	-	-	-	-	-	-	-	-	-		-	-	-
ISUZU (Continued)															
4-Flat	06-08	3W	E	65-60022		10	11.2						4-Flat	65-75330	65-75375
JEEP (Continued)															
-	-	-	-	-	-	-	-	-	-	-	-		-	-	-
4-Flat	11-15	2W	F	65-60012	A1, A2	5	15.4	11-13	65-75294	C	5				
4-Flat	05-08	2W	E	65-61003	A1, A2	5	15.4	-	-	-	-		4-Flat	65-75330	65-75375
4-Flat	09-12	2W	F	65-60012	A1, A2	5	15.4								
4-Flat	07-15	2W	A	65-61124	A1, A11	10	15.4	-	-	-	-		-	-	-
KIA (Continued)															
4-Flat	10-16	3W	A,B	65-66003	A3	15	11.2	-	-	-	-		-	-	-
4-Flat	11-14	3W	G	65-66211	A3, A12	5	11.2	-	-	-	-		-	-	-
LINCOLN (Continued)															
4-Flat	07-09	2W	A,B	65-62055	A3	35	11.2	-	-	-	-		4-Flat	-	65-75375
4-Flat	11-14	2W	A,B	65-62058	A3	35	11.2								
NISSAN (Continued)															
4-Flat	05-16	2W	E	65-64004	A1, A8	5	15.4	05-15	65-75286	E	5		-	-	-
T-CONNECTOR FOOTNOTE:															
A10: Excl. Chrome 08-13		A11: Excl. Limited and RH Drive		A12: 6 Cyl. W/Factory Towing		A13: Fit SuperCrew Cab Only		A14: Excl. Cross Cabriolet		A15: Vehicle without LED Tailights (Std Bulbs)		A16: Vehicle with LED Tailights		A17: Hatchback Only	
WIRING LOCATIONS	A	Behind the driver's side tail light housing								LEGEND					
	B	Behind the passenger's side tail light housing								WC	Weight Capacity		ELECTRICAL SYSTEM TYPE		
	C	Behind the driver's side cargo area interior access panel								WD	Weight Distribution		2W	2-wire system	
	D	Behind the passenger's side cargo interior access panel								ST	Stop, Tail		3W	3-wire system	
	E	Under the vehicle, behind the bumper fascia on the driver's side								STT	Stop, Tail, Turn		PWM	ST or STT	
	F	Under the vehicle, behind the bumper fascia near the center of the vehicle													
G	Under the vehicle, behind the bumper fascia on the passenger's side														

RECEIVER HITCHES

CLASS I
(200/2,000 LBS TW/GTW)

CLASS III / IV
(350-600/3,500-6,000 LBS TW/GTW)

MODEL/STYLE	YEAR	HITCH PART#	FOOTNOTE	TUBE STYLE	WC (LBS)	INSTALL TIME (MIN)	HITCH PART#	FOOTNOTE	WC (LBS)	WD (LBS)	INSTALL TIME (MIN)	TUBE STYLE
NISSAN												
Murano	09-14	-		-	-	-	65-1455		350/3500	-	45	Round
Murano	15-16	-		-	-	-	65-1525		350/3,500	-	45	Round
Pathfinder	13-16	-		-	-	-	65-1395	12	350/3,500	500/5,000	90	Round
Rogue	08-13	65-1335		Round	200/2,000	60	-	-	-	-	-	-
Rogue	14-16	65-1425		Round	200/2,000	60	-	-	-	-	-	-
PONTIAC												
Torrent	06-09	-		-	-	-	65-1075	1,4	350/3,500	400/4,000	45	Round
RAM												
C/V Tradesman	10-16	-		-	-	-	65-1175		350/3,500	600/6,000	90	Round
SATURN												
Outlook	07-10	-		-	-	-	65-1085	1,4,7,9	500/5,000	600/6,000	60	Round
SUBARU												
Forrester	14-16	-		-	-	-	65-1545	7,8	350/3,500	-	60	Round
Outback	14-16	-		-	-	-	65-1555	7,8	350/3,500	-	-	-
SUZUKI												
Equator	09-12						65-1185		500/5,000	600/6,000	30	Square
TOYOTA												
Highlander	08-13	-		-	-	-	65-1115	1,3,4	500/5,000	600/6,000	90	Round
Highlander	14-16	-		-	-	-	65-1365	12	500/5,000	800/8,000	90	Round
Prius	10-15	65-1255		Round	200/2,000	60	-	-	-	-	-	-
RAV4	06-16	65-1125		Round	200/2,000	30	-	-	-	-	-	-
Sienna	04-16	-		-	-	-	65-1415	3	350/3,500	500/5,000	45	Round
Tacoma	05-15	-		-	-	-	65-1045	1,4,5	500/5,000	600/6,000	60	Square
Tundra	07-16	-		-	-	-	65-1315		500/5,000	800/8,000	30	Round
VOLKSWAGEN												
Routan	08-12	-		-	-	-	65-1175		350/3,500	500/5,000	90	Round

NOTES:

T-CONNECTOR FOOTNOTE:

	A1: Tail light converter not included	A2: Fit vehicle W/Factory 7-Way	A3: Tail light converter included	A4: 4Dr Sedan only	A5: Excl. Plug-In Models	A6: SE Models Only	A7: Fits All Models	A8: Vehicle with Factory Tow	A9: Vue Red Line	
RECEIVER HITCH	1	Will not fit vehicle with factory installed hitch receiver				8	Trimming of exhaust heat shield is required for installation			
	2	Trimming of rear bumper fascia may be required for sport models				9	Factory bumper hitch cover can be re-installed after installation			
	3	Trimming of rear bumper insert and rear splash shields may be required for installation				10	Excludes 97/98 F150/250LD			
	4	Requires OEM style rear bumper and mounting bracket				11	Will not fit vehicles built on or before Nov. 2002			
	5	Excludes fitment on X-Runner model				12	Trimming required			
	6	Drilling required for installation				13	Receiver only, no cross tube			
	7	Exhaust system needs to be temporarily lowered for installation				14	Exclude Sedan & Sport Edition			

ELECTRICAL															
T-CONNECTOR								BRAKE CONTROL HARNESS					TAIL LIGHT CONVERTER		
OUTPUT	YEAR	ELECTRICAL SYSTEM TYPE	WIRING LOCATION	PART #	FOOTNOTE	INSTALL TIME (MIN)	AMP	YEAR	PART #	WIRING LOC	INSTALL TIME (MIN)	NOTES	OUTPUT	STANDARD PART	CIRCUIT PROTECTION
NISSAN (Continued)															
4-Flat	03-05	3W	C,D	65-64106	A3, A14	20	11.2	-	-	-	-		-	-	-
4-Flat	09-14	3W	C,D	65-64106	A3, A14	45	11.2								
4-Flat	15-16	3W	C,D	65-64106	A3, A14	45	11.2	-	-	-	-		-	-	-
		N/A	N/A	N/A		N/A		05-15	65-75286	E	5				
4-Flat	08-13	3W	C,D	65-64150	A3, A10	40	11.2	-	-	-	-		-	-	-
4-Flat	14-16	3W	C,D	65-64150	A3	40	11.2	-	-	-	-		-	-	-
PONTIAC (Continued)															
4-Flat	06	2W	A,B	65-60037	A3	10	11.2	-	-	-	-		-	-	-
4-Flat	07-09	3W	C	65-60038	A1	10	11.2								
RAM (Continued)															
4-Flat	10-16	2W	A,B	65-61029	A3	35	11.2	-	-	-	-		-	-	-
SATURN															
4-Flat	07-09	2W	F	65-60012	A1, A2	5	15.4	07-09	65-75289	A	15		-	-	-
4-Flat	07-09	2W	A,B	65-60070	A1	15	15.4								
SUBARU (Continued)															
4-Flat	14-16	3W	C	65-66302	A3	15	11.2	-	-	-	-		-	-	-
4-Flat	10-15	3W	C	65-66302	A3	15	11.2	-	-	-	-		-	-	-
SUZUKI (Continued)															
4-Flat	09-11	2W	A,B	65-64004	A3, A8	5	15.4						4-Flat	65-75330	65-75375
TOYOTA (Continued)															
4-Flat	08-16	3W	C,D	65-65133	A3,A7	20	11.2	-	-	-	-		-	-	-
4-Flat	08-16	3W	C,D	65-65133	A3, A7	20	11.2	-	-	-	-		-	-	-
4-Flat	04-10	3W	C,D	65-65418	A3, A7	20	11.2	-	-	-	-		-	-	-
4-Flat	2012	3W	C,D	65-65418	A3, A4, A5	20	11.2								
4-Flat	06-12	3W	C,D	65-65113	A3	20	11.2	-	-	-	-		4-Flat	65-75330	65-75375
4-Flat	13-16	3W	C,D	65-65117	A3	20	11.2								
4-Flat	04-10	3W	A,B	65-65202	A3	15	11.2	-	-	-	-		4-Flat	65-75330	65-75375
4-Flat	11-14	3W	A,B	65-65203	A3, A7	35	11.2								
4-Flat	2015	3W	A,B	65-65203	A3, A6	35	11.2								
4-Flat	05-09	3W	A,B	65-65002	A3	10	11.2	07-16	65-75285	G	5		4-Flat	65-75330	65-75375
4-Flat	10-15	3W	A,B	65-65005	A3	10	11.2	-	-	-	-		-	-	-
4-Flat	10-15	2W	F	65-60012	A1, A2	5	15.4	07-16	65-75285	G	5		-	-	-
4-Flat	10-15	2W	G	65-60013	A1, A2	5	15.4								
VOLKSWAGEN (Continued)															
-	-	-	-	-	-	-	-	-	-	-	-		-	-	-

NOTES:

T-CONNECTOR FOOTNOTE:

A10: Excl. Chrome 08-13	A11: Excl. Limited and RH Drive	A12: 6 Cyl. W/Factory Towing	A13: Fit SuperCrew Cab Only	A14: Excl. Cross Cabriolet	A15: Vehicle without LED Tailights (Std Bulbs)	A16: Vehicle with LED Tailights	A17: Hatchback Only
WIRING LOCATIONS	A	Behind the driver's side tail light housing			LEGEND		
	B	Behind the passenger's side tail light housing			WC	Weight Capacity	
	C	Behind the driver's side cargo area interior access panel			WD	Weight Distribution	
	D	Behind the passenger's side cargo interior access panel			ST	Stop, Tail	
	E	Under the vehicle, behind the bumper fascia on the driver's side			STT	Stop, Tail, Turn	
	F	Under the vehicle, behind the bumper fascia near the center of the vehicle			2W	2-wire system	
	G	Under the vehicle, behind the bumper fascia on the passenger's side			3W	3-wire system	
					PWM	ST or STT	

APPLICATION CHART

CLASS I RECEIVER HITCHES

- Up to 2,000 lbs. towing
- 1.25" receiver opening (A)
- 2" heavy duty main body tubes
- Unique delta cut safety chain loops (B)
- Steel capped tube ends include a rubber plug for a finished look*
- Features a through bracket construction with double sided welds*
- E-Coated steel for maximum corrosion protection (C)
- Includes mounting tab for electrical connector
- Stylized forged steel collar
- No-drilling required*
- Tested and validated by an independent lab to SAE specification J684 (SAE J684 supersedes V.E.S.C. Regulation V5)
- Textured black powder coat finish (D)



STYLIZED FORGED STEEL COLLAR



DOUBLE SIDED WELDS*

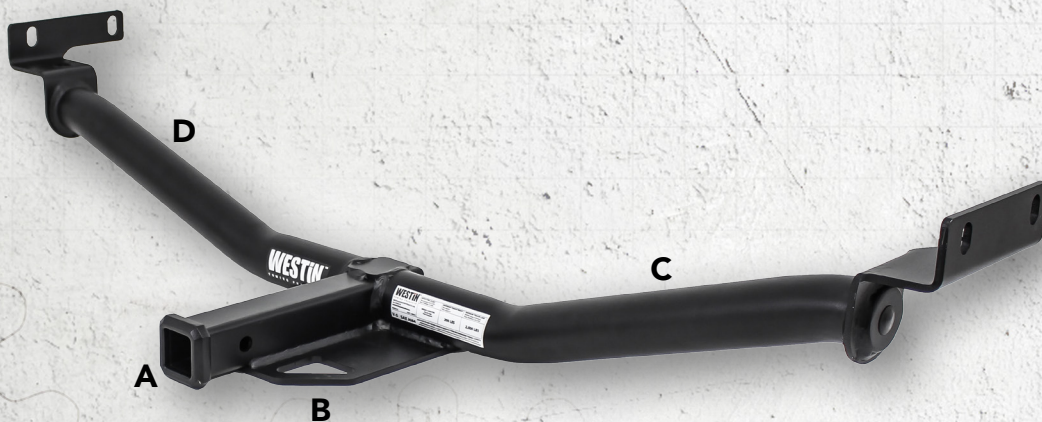

3 YEAR FINISH WARRANTY **LIMITED LIFETIME WORKMANSHIP WARRANTY**

PATENT PENDING

Disclaimer: Always adhere to a vehicle's manufacturer recommended towing specifications. Improper use or installation of these products will void warranty and may result in vehicle damage, personal injury or injury to others. Professional installation of Westin towing products is recommended.

* FOR MOST APPLICATIONS



CLASS III/IV

RECEIVER HITCHES

- Up to 5,000 lbs. towing (Class III)
- Up to 10,000 lbs. towing (Class IV)
- 2" receiver opening (A)
- Main cross tube made of structural steel*
- Unique delta cut safety chain loops (B)
- Steel capped tube ends include a rubber plug for a finished look*
- Features a through bracket construction with double sided welds*
- E-Coated steel for maximum corrosion protection (C)
- Includes mounting tab for electrical connector
- Stylized forged steel collar
- No drilling required*
- Tested and validated by an independent lab to SAE specification J684 (SAE J684 supersedes V.E.S.C. Regulation V5)
- Textured black powder coat finish (D)



STRUCTURAL STEEL CROSS TUBE

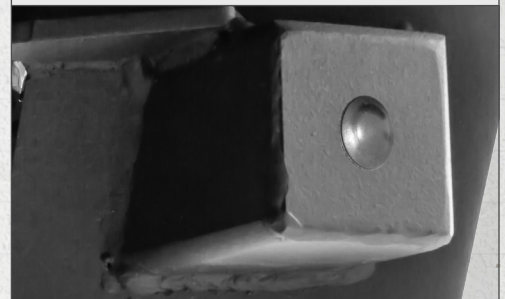

CAPPED TUBE ENDS

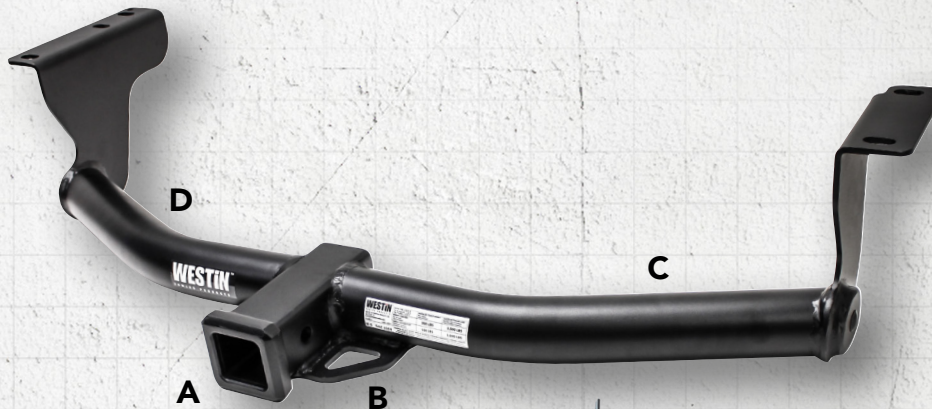

3 YEAR FINISH WARRANTY **LIMITED LIFETIME WORKMANSHIP WARRANTY**

PATENT PENDING

Disclaimer: Always adhere to a vehicle's manufacturer recommended towing specifications. Improper use or installation of these products will void warranty and may result in vehicle damage, personal injury or injury to others. Professional installation of Westin towing products is recommended.

* FOR MOST APPLICATIONS



RECEIVER HITCHES

RECEIVER HITCHES

CLASS I, III/IV APPLICATIONS

START	END	MAKE	MODEL	CLASS	TW/GTW	WT DIST RATING	RECEIVER	TUBE	SHAPE	INSTALL EASE	INSTALL TIME	PART #
2008	2016	Buick	Enclave ^{1,4,7,9}	III	500/5,000	600/6,000	2"	2.5"	Round	2	1	65-1085
2007	2016	GMC	Acadia ^{1,4,7,9}	III	500/5,000	600/6,000	2"	2.5"	Round	2	1	65-1085
2010	2016	GMC	Terrain	I	200/2,000	-	1.25"	1.5"	Round	1	0.75	65-1345
2010	2016	GMC	Terrain ^{1,4}	III	350/3,500	400/4,000	2"	2.5"	Round	1	0.75	65-1075
2004	2016	Chevy	Equinox	I	200/2,000	-	1.25"	2"	Round	1	0.75	65-1345
2004	2016	Chevy	Equinox ^{1,4}	III	350/3,500	400/4,000	2"	2.5"	Round	1	0.75	65-1075
2009	2013	Chevy	Traverse ^{1,4,7,9}	III	500/5,000	600/6,000	2"	2.5"	Round	2	1	65-1085
2015	2016	Chevy/ GMC	Colorado/Canyon	III	500/5,000	800/8,000	2"	2.5"	Round	1	0.75	65-1535
2004	2012	Chevy/ GMC	Colorado/Canyon ¹	III	400/4,000	600/6,000	2"	2.5"	Round	1	1	65-1145
1996	2016	Chevy/ GMC	Express/Savana	III / IV	600/6,000	1,000/10,000	2"	2.5"	Square	1	0.5	65-1135
2014	2016	Chevy/ GMC	Silverado/Sierra 1500	III / IV	600/6,000	1,000/10,000	2"	2.5"	Round	1	0.75	65-1475
2007	2013	Chevy/ GMC	Silverado/Sierra 1500 ^{1,4}	III / IV	600/6,000	1,000/10,000	2"	2.5"	Round	1	0.75	65-1005
1999	2007	Chevy/ GMC	Silverado/Sierra Classic ^{1,4}	III / IV	600/6,000	1,000/10,000	2"	2.5"	Round	1	0.75	65-1005
1999	2005	Chevy/ GMC	Silverado/Sierra 2500LD ^{1,4}	III / IV	600/6,000	1,000/10,000	2"	2.5"	Round	1	0.75	65-1005
2008	2016	Chrysler	Town & Country ⁷	III	350/3,500	500/5,000	2"	2.5"	Round	2	1.5	65-1175
2008	2016	Chrysler	Caravan ⁷	III	350/3,500	500/5,000	2"	2.5"	Round	2	1.5	65-1175
2011	2016	Dodge/Ram	Durango ^{1,4}	III	500/5,000	800/8,000	2"	2.5"	Round	1	0.75	65-1055
2009	2016	Dodge/Ram	Journey	III	350/3,500	-	2"	2.5"	Round	2	40	65-1275
2003	2016	Dodge/Ram	Ram 1500 ^{1,4,11,13}	III/IV	600/6,000	1,000/10,000	2"	N/A	N/A	2	1	65-1015
2010	2014	Dodge/Ram	Ram C/V Tradesman ⁷	III	350/3,500	500/5,000	2"	2.5"	Round	2	1.5	65-1175
2015	2016	Ford	F-150 XL ¹	III/IV	600/6,000	1,000/10,000	2"	2.5"	Round	2	1	65-1515
2000	2014	Ford	E-150/250/350	III / IV	600/6,000	1,000/10,000	2"	2.5"	Square	1	0.5	65-1165
2007	2014	Ford	Edge ^{1,2,4,6,7,8}	III	400/4,000	-	2"	2.5"	Round	3	1.5	65-1105
2013	2016	Ford	Escape	I	200/2,000	-	1.25"	2"	Round	2	1	65-1265
2005	2012	Ford	Escape ^{1,4}	III	350/3,500	500/5,000	2"	2.5"	Round	2	1.2	65-1095
2011	2016	Ford	Explorer ^{1,4,7}	III	500/5,000	600/6,000	2"	2.5"	Round	2	1	65-1235
2006	2008	Ford	F-150	III/IV	600/6,000	1,000/10,000	2"	2.5"	TBD	2	1	65-1485
2009	2014	Ford	F-150 ^{1,4}	III/IV	600/6,000	1,000/10,000	2"	2.5"	Square	2	1	65-1025
2012	2016	Ford	Focus (Excl Sedan & Sports) ⁷	I	200/2,000	-	1.25"	2"	Round	1	0.5	65-1205
1983	2011	Ford	Ranger ^{1,4,6}	III	400/4,000	600/6,000	2"	2.5"	Square	2	0.75	65-1065
2012	2016	Honda	CRV ⁷	I	200/2,000	-	1.25"	2"	Round	1	0.75	65-1385
1999	2016	Honda	Odyssey	III	350/3,500	-	2"	2.5"	Round	2	1	65-1305
2014	2016	Hyundai	Santa Fe	III	350/3,500	500/5,000	2"	2.5"	Round	1	0.5	65-1405
2004	2012	Isuzu	I-Series ¹	III	400/4,000	600/6,000	2"	2.5"	Round	1	1	65-1145
2011	2016	Jeep	Compass	TBD	TBD	TBD	TBD	TBD	TBD	TBD	TBD	65-1445
2011	2015	Jeep	Grand Cherokee ^{1,4}	III	500/5,000	800/8,000	2"	2.5"	Round	1	0.5	65-1055
2008	2013	Jeep	Liberty	III	350/3,500	-	2"	2.5"	Round	1	0.25	65-1325
2007	2016	Jeep	Wrangler ^{1,4,13}	III	350/3,500	-	2"	N/A	N/A	1	0.5	65-1035

START	END	MAKE	MODEL	CLASS	TW/GTW	WT DIST RATING	RECEIVER	TUBE	SHAPE	INSTALL EASE	INSTALL TIME	PART #
2014	2016	Kia	Soul ⁶	I	200/2,000	-	1.25"	2"	Round	1	0.5	65-1245
2014	2015	Kia	Sorento	III	350/3,500	500/5,000	TBD	TBD	TBD	TBD	TBD	65-1405
2005	2016	Nissan	Frontier	III	500/5,000	600/6,000	2"	2.5"	Square	1	0.5	65-1185
2015	2016	Nissan	Murano	III	350/3,500	-	2"	2.5"	Round	1	0.75	65-1525
2009	2014	Nissan	Murano	III	350/3,500	-	2"	2.5"	Round	TBD	TBD	65-1455
2013	2016	Nissan	Pathfinder ¹²	III	350/3,500	500/5,000	2"	2.5"	Round	2	1.5	65-1395
2008	2013	Nissan	Rogue	I	200/2,000	-	1.25"	2"	Round	2	1	65-1335
2014	2016	Nissan	Rogue	I	200/2,000	-	1.25"	2"	Round	2	1	65-1425
2006	2009	Pontiac	Torrent ^{1,4}	III	350/3,500	400/4,000	2"	2.5"	Round	1	0.75	65-1075
2007	2010	Saturn	Outlook ^{1,4,7,9}	III	500/5,000	600/6,000	2"	2.5"	Round	2	1	65-1085
2004	2010	Saturn	Vue	I	200/2,000	-	1.25"	2"	Round	1	0.75	65-1345
2014	2016	Subaru	Forester ^{7,8}	III	350/3,500	-	2"	2.5"	Round	1	0.75	65-1545
2014	2016	Subaru	Outback ^{7,8}	III	350/3,500	-	2"	2.5"	Round	2	0.75	65-1555
2009	2012	Suzuki	Equator	III	500/5,000	600/6,000	2"	2.5"	Square	1	0.5	65-1185
2014	2016	Toyota	Highlander ¹²	III	500/5,000	800/8,000	2"	2.5"	Round	3	1.5	65-1365
2008	2013	Toyota	Highlander ^{1,3,4}	III	500/5,000	600/6,000	2"	2.5"	Round	2	1.5	65-1115
2010	2015	Toyota	Prius	I	200/2,000	-	1.25"	2"	Round	1	1	65-1255
2006	2016	Toyota	Rav 4 (Excl. electric vehicles)	I	200/2,000	-	1.25"	2"	Round	1	0.5	65-1125
2004	2016	Toyota	Sienna ³	III	350/3,500	500/5,000	2"	2.5"	Round	1	0.75	65-1415
2005	2015	Toyota	Tacoma ^{1,4,5}	III	500/5,000	600/6,000	2"	2.5"	Square	2	1	65-1045
2007	2016	Toyota	Tundra	III	500/5,000	800/8,000	2"	2.5"	Round	1	0.3	65-1315
2008	2012	Volkswagen	Routan ⁷	III	350/3,500	500/5,000	2"	2.5"	Round	2	1.5	65-1175

INSTALL EASE GUIDE

1 - EASY

2 - MODERATE

3 - DIFFICULT

FOOTNOTE

- | | |
|--|--|
| 1 Will not fit vehicle with factory installed hitch receiver | 8 Trimming of exhaust heat shield is required for installation |
| 2 Trimming of rear bumper fascia may be required for sport models | 9 Factory bumper hitch cover can be re-installed after installation |
| 3 Trimming of rear bumper insert and rear splash shields may be required for installation | 10 Excludes 97/98 F150/250LD |
| 4 Requires OEM style rear bumper and mounting bracket | 11 Will not fit vehicles built on or before Nov. 2002 |
| 5 Excludes fitment on X-Runner model | 12 Trimming required |
| 6 Drilling required for installation | 13 Hitch receiver only, no cross tube |
| 7 Exhaust system needs to be temporarily lowered for installation | |

DIFFERENT CLASS OF HITCHES



CLASS I



CLASS III/IV (ROUND)



CLASS III/IV (SQUARE)

Disclaimer: Always adhere to a vehicle's manufacturer recommended towing specifications. Improper use or installation of these products will void warranty and may result in vehicle damage, personal injury or injury to others. Professional installation of Westin towing products is recommended.

T-CONNECTORS

ELECTRICAL

Westin offers a complete, comprehensive line of T-Connectors to take the guess work out of towing. Kits are complete and comprehensive that are vehicle specific. Complete one-piece harness designs with built-in tail light converters (where applicable). All T-Connectors contain OEM quality harness components, terminals and connection housings. Our T-Connectors use a 16 gauge copper wire for lasting durability, superior current flow and complete installation instructions.

T-CONNECTORS FEATURES

- Complete, one-piece harness designs
- Engineered to highest industry standards
- Built in tail light converters, where applicable
- All T-Connectors contain OEM quality harness components, terminals, and connection housings
- 100% copper stranded wire
- Professional installation recommended

Over molded for PCB protection

100% copper stranded wire

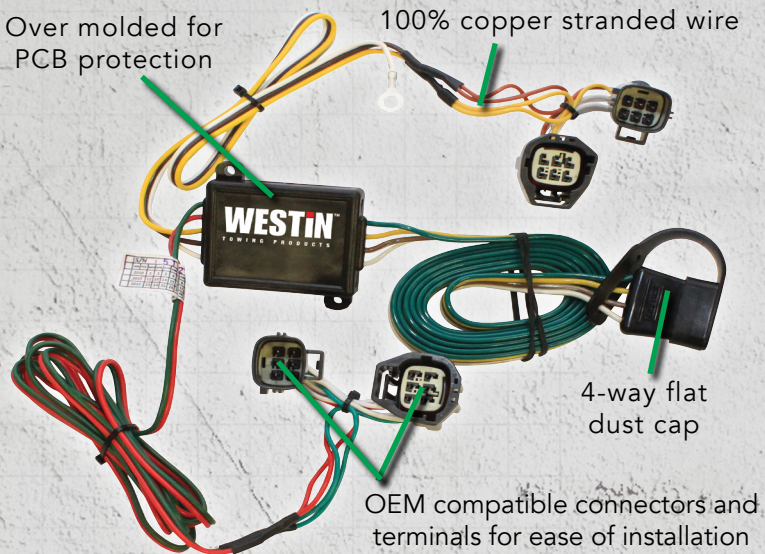

4-way flat dust cap

OEM compatible connectors and terminals for ease of installation

WIRING LOCATION GUIDE (Truck & SUVs)

Position are shown by letter

- A** - Behind the driver's side tail light housing
- B** - Behind the passenger's side tail light housing
- C** - Behind the driver's side cargo area interior access panel
- D** - Behind the passenger's side cargo area interior access panel
- E** - Under the vehicle, behind the bumper fascia on the driver's side
- F** - Under the vehicle, behind the bumper fascia near the center of the vehicle
- G** - Under the vehicle, behind the bumper fascia on the passenger's side



ELECTRICAL SYSTEM TYPES

2 WIRE SYSTEMS (2W)

2-wire systems can be identified by the use of a single bulb on each side of the vehicle/trailer to provide both stop lamp and turn signal illumination.

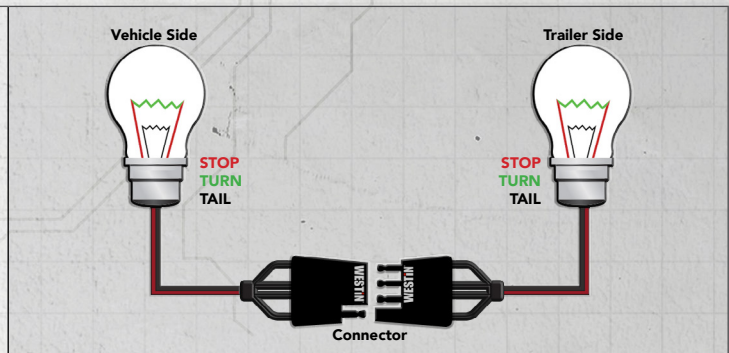

3 WIRE SYSTEMS (3W)

3-wire systems utilize separate wires to provide power to the stop lamp and turn signal bulbs. 3-wire systems can be identified by twin bulbs in each side of the vehicle/trailer.

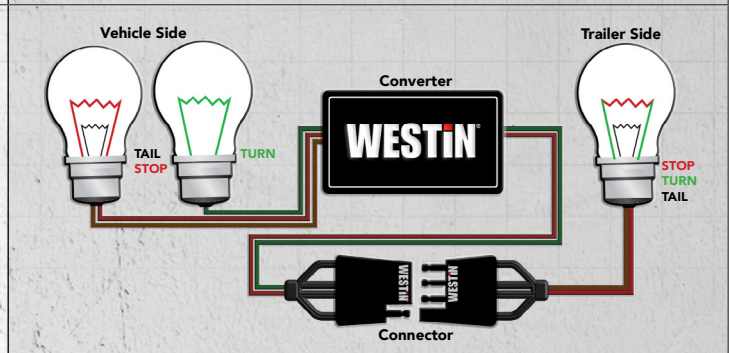

PULSE WIDTH MODULATION SYSTEMS (PWM)

These are systems that vary the signal intensity over one wire to initiate more than one lighting function. One wire can control more than one light function. PWM systems can be either incandescent or LED. There are two types of PWM systems ST and STT.

ST SYSTEMS

Have two wires, one wire that contains both stop and tail functions, and a separate wire on each side that contains the turn signal functions.

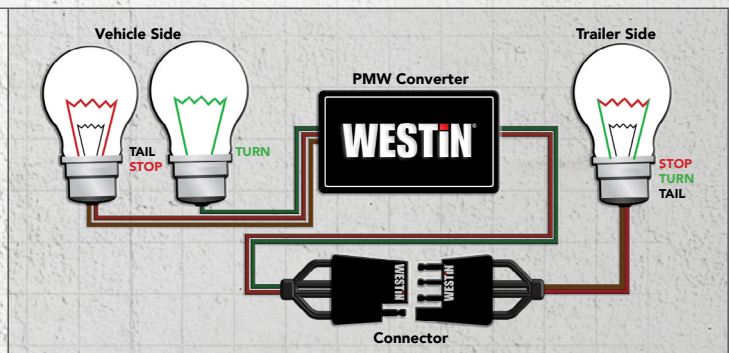

STT SYSTEMS

Have one wire that contains stop, tail and turn functions.

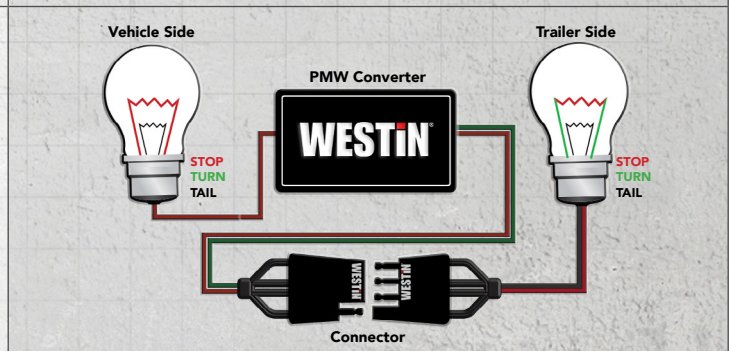

Note: Refer to page 4-11 for ST & STT system vehicle applications

T-CONNECTORS

APPLICATIONS

START	END	MAKE	MODEL	ELECTRIC SYSTEM TYPE	WIRING LOCATION	INSTALL TIME (MIN)	NOTES	PART #
2009	2014	Acura	TSX	3W	C, D	10		65-63104
2007	2014	Acura	RDX	3W	D	10		65-63110
1994	2001	Acura	Integra	3W	C	5		65-63101
1996	2001	Acura	RL	3W	C	5		65-63101
1997	2003	Acura	CL & CL 2.2	3W	C	5		65-63101
1996	2003	Acura	TL Series	3W	C	5		65-63101
2001	2006	Acura	MDX	3W	C, D	10		65-63101
2006	2008	Acura	TSX	3W	C	5		65-63102
2007	2013	Acura	MDX	3W	C	20		65-63109
2008	2015	Buick	Enclave	2W	G	5	OE Replacement 4-Flat	65-60013
2008	2015	Buick	Enclave	2W	F	5		65-60012
2013	2016	Buick	Enclave	3W	A, B	35		65-60016
2004	2007	Buick	Ranier	2W	F	5		65-60012
2002	2007	Buick	Rendezvous	2W	A, B	20		65-60053
2005	2007	Buick	Terraza	2W	C	5		65-60056
2006	2011	Buick	Lucerne	2W	C, D	10		65-60062
2008	2012	Buick	Enclave	2W	A, B	5		65-60067
2001	2016	Cadillac	Escalade & Escalade Ext	2W	G	5	OE Replacement 4-Flat	65-60013
2001	2016	Cadillac	Escalade ESV	2W	G	5	OE Replacement 4-Flat	65-60013
2001	2016	Cadillac	Escalade & Escalade Ext	2W	F	5		65-60012
2001	2016	Cadillac	Escalade ESV	2W	F	5		65-60012
2013	2014	Chevy	Traverse	3W	A, B	35		65-60015
2010	2016	Chevy	Equinox	2W	A, B	10		65-60072
2010	2016	Chevy	Terrain	2W	A, B	10		65-60072
2013	2014	Chevy	Malibu	3W	C, D	35	Does not fit LTZ model	65-60083
1997	2003	Chevy	Malibu	3W	C, D	20		65-60066
1997	2005	Chevy	Venture	3W	C	10		65-60052
2000	2005	Chevy	Impala	2W	C, D	10		65-60059
2005	2006	Chevy	Equinox	3W	C	10		65-60037
2004	2007	Chevy	Malibu	2W	C, D	5		65-60065
2004	2007	Chevy	Malibu Maxx	2W	C, D	5		65-60065
2005	2008	Chevy	Uplander	2W	C	10		65-60056
2007	2009	Chevy	Equinox	2W	C	15		65-60038
1999	2010	Chevy	Trailblazer	2W	F	5		65-60012
2008	2010	Chevy	HHR SS	2W	A, B	10		65-60039
2005	2011	Chevy	Cobalt 2 Dr.	2W	A, B	10		65-60039
2008	2011	Chevy	Cobalt Sport 2 Dr.	2W	A, B	10		65-60039
2005	2011	Chevy	Cobalt SS 2 Dr.	2W	A, B	10		65-60039
2006	2011	Chevy	HHR	2W	A, B	10		65-60039
2005	2011	Chevy	Cobalt 4 Dr.	2W	A, B	10		65-60060
2008	2011	Chevy	Cobalt Sport 4 Dr.	2W	A, B	10		65-60060
2005	2011	Chevy	Cobalt SS 4 Dr.	2W	A, B	10		65-60060
2002	2012	Chevy	Avalanche	2W	F	5	Adds 4-Flat to OE 7-Way	65-60012
2000	2015	Chevy	Suburban	2W	G	5	OE Replacement 4-Flat	65-60013
2000	2015	Chevy	Suburban	2W	F	5		65-60012
2000	2015	Chevy	Traverse	2W	G	5	OE Replacement 4-Flat	65-60013
2000	2015	Chevy	Tahoe	2W	G	5	OE Replacement 4-Flat	65-60013
2008	2012	Chevy	Malibu	2W	A, B	5	Does not fit LTZ model	65-60067
2009	2012	Chevy	Traverse	2W	A, B	10		65-60067
2006	2013	Chevy	Impala	2W	B	10		65-60061
1999	2016	Chevy/GMC	Silverado / Sierra 1500	2W	G	5	Adds 4-Flat to OE 7-Way	65-60012
1999	2015	Chevy/GMC	Silverado / Sierra 1500	2W	G	5	OE Replacement 4-Flat	65-60013
2007	2015	Chevy/GMC	Acadia	2W	G	5	OE Replacement 4-Flat	65-60013
2007	2015	Chevy/GMC	Acadia	2W	F	5		65-60012
2013	2014	Chevy/GMC	Acadia	3W	A, B	35		65-60016
1988	1998	Chevy/GMC	C/K Series 1500	2W	E	5	4-Flat connector	65-60003
1996	1999	Chevy/GMC	Express / Savana	3W	C, D	10		65-60042
1988	2000	Chevy/GMC	C/K Series 25/3500	2W	E	5	4-Flat connector	65-60003
1999	2001	Chevy/GMC	Blazer / Jimmy Downsize	2W	F	5		65-60012
2000	2002	Chevy/GMC	Express / Savana	3W	C, D	10		65-60044
1998	2004	Chevy/GMC	S-10 / S-15, Sonoma	2W	E	5		65-60021
1999	2015	Chevy/GMC	Silverado / Sierra 2500LD	2W	G	5	OE Replacement 4-Flat	65-60013
1999	2010	Chevy/GMC	Envoy	2W	F	5		65-60012
2004	2016	Chevy/GMC	Colorado / Canyon	2W	F	5	Adds 4-Flat to OE 7-Way	65-60012
2004	2016	Chevy/GMC	Colorado / Canyon	2W	G	5	OE Replacement 4-Flat	65-60013

START	END	MAKE	MODEL	ELECTRIC SYSTEM TYPE	WIRING LOCATION	INSTALL TIME (MIN)	NOTES	PART #
2001	2016	Chevy/GMC	Silverado / Sierra 25/3500HD	2W	G	5	Adds 4-Flat to OE 7-Way	65-60012
2001	2016	Chevy/GMC	Silverado / Sierra 3500 Cab & Chassis	2W	G	5	Adds 4-Flat to OE 7-Way	65-60012
2000	2016	Chevy/GMC	Tahoe & Denali	2W	G	5	Adds 4-Flat to OE 7-Way	65-60012
2000	2016	Chevy/GMC	Yukon & Yukon XL	2W	G	5	OE Replacement 4-Flat	65-60013
2001	2016	Chevy/GMC	Yukon Denali & Yukon Denali XL	2W	G	5	OE Replacement 4-Flat	65-60013
2000	2016	Chevy/GMC	Yukon & Yukon XL	2W	F	5		65-60012
2001	2016	Chevy/GMC	Yukon Denali & Yukon Denali XL	2W	F	5		65-60012
2001	2016	Chevy/GMC	Silverado / Sierra 25/3500HD	2W	G	5	OE Replacement 4-Flat	65-60013
2007	2012	Chevy/GMC	Acadia	2W	A, B	10		65-60014
2004	2012	Chevy/GMC	Colorado / Canyon	3W	E	10		65-60022
2003	2016	Chevy/GMC	Express / Savana	2W	C, D	30		65-60045
1973	1984	Chevy/GMC	Full Size Trucks & SUV's	2W	E	10		65-60001
2011	2014	Chrysler	300	3W	C, D	30		65-61039
2011	2014	Chrysler	300C	3W	C, D	30		65-61039
1988	1990	Chrysler	Town & Country	2W	A, B	10		65-61021
1991	1995	Chrysler	Town & Country	2W	A, B	10		65-61022
1991	1995	Chrysler	Caravan / Grand Caravan	2W	A, B	10		65-61022
1996	2000	Chrysler	Town & Country	3W	A, B	20		65-61023
1996	2000	Chrysler	Caravan / Grand Caravan	3W	A, B	20		65-61023
2001	2003	Chrysler	Town & Country	3W	A, B	15		65-61024
2001	2003	Chrysler	Caravan / Grand Caravan	3W	A, B	15		65-61024
2004	2007	Chrysler	Town & Country	2W	A, B	10		65-61025
2004	2007	Chrysler	Town & Country w/ Stow-N-Go	2W	A, B	10		65-61025
2004	2007	Chrysler	Caravan / Grand Caravan	2W	A, B	10		65-61025
2007	2007	Chrysler	Caliber	3W	C, D	45		65-61050
2007	2008	Chrysler	Aspen	2W	F	5	Adds 4-Flat to OE 7-Way	65-61003
2004	2008	Chrysler	Pacifica	2W	F	5		65-61003
2004	2008	Chrysler	Pacifica	3W	A, B	10		65-61045
2009	2009	Chrysler	Aspen	2W	F	5		65-60012
2007	2009	Chrysler	Aspen	3W	A, B	10		65-61026
2008	2010	Chrysler	Town & Country	2W	A, B	35		65-61028
2008	2010	Chrysler	Caravan / Grand Caravan	2W	A, B	35		65-61028
2000	2010	Chrysler	PT Cruiser	3W	A, B	30		65-61041
2011	2016	Chrysler	Town & Country	2W	A, B	35		65-61029
2011	2016	Chrysler	Caravan / Grand Caravan	3W	A, B	35		65-61029
2013	2014	Dodge	Journey (w/out Taillights)	2W	A, B	35	W/Out LED Taillights (Standard Bulbs)	65-61052
2011	2014	Dodge	Journey (w/ LED Taillights)	3W	A, B	35	With LED Taillights	65-61053
1986	1993	Dodge	Ram Charger	2W	E, F	5		65-61001
1987	1994	Dodge	Dakota	2W	E, G	5		65-61001
1986	1994	Dodge	Ram 1500	2W	E, F	5		65-61001
1986	1994	Dodge	Ram 25/3500	2W	E, F	5		65-61001
1995	2001	Dodge	Ram 1500	2W	E, F	5		65-61002
1994	2002	Dodge	Ram Full Size Cab & Chassis	2W	E, F	5		65-61001
1995	2002	Dodge	Ram 25/3500	2W	E, F	5		65-61002
1995	2003	Dodge	Dakota	2W	E, G	10		65-61002
2001	2003	Dodge	Van, Full Size	2W	G	5	Adds 4-Flat to OE 7-Way	65-61003
1998	2003	Dodge	Durango	3W	A, B	20		65-61023
2002	2005	Dodge	Ram 1500	3W	A, B	5		65-61004
2003	2005	Dodge	Ram 25/3500	3W	A, B	5		65-61004
2007	2007	Dodge	Caliber	3W	A, B	35		65-61050
2000	2008	Dodge	Durango	2W	F	5	Adds 4-Flat to OE 7-Way	65-61003
2000	2008	Dodge	Ram 1500	2W	G	5	Adds 4-Flat to OE 7-Way	65-61003
2009	2015	Dodge	Durango	2W	G	5	OE Replacement 4-Flat	65-60013
2009	2015	Dodge	Durango	2W	F	5		65-60012
2000	2009	Dodge	Dakota	2W	G	5	Adds 4-Flat to OE 7-Way	65-61003
2000	2009	Dodge	Ram 25/3500HD	2W	G	5	Adds 4-Flat to OE 7-Way	65-61003
2003	2009	Dodge	Sprinter	2W	G	5	Adds 4-Flat to OE 7-Way	65-61003
2004	2009	Dodge	Durango	3W	A, B	10		65-61026
2009	2009	Dodge	Journey	3W	C, D	15		65-61051
2010	2010	Dodge	Journey	2W	A, B	35		65-61052
2003	2011	Dodge	Dakota	2W	A, B	10		65-61022
2007	2011	Dodge	Nitro	3W	A, B	10		65-61027
2008	2012	Dodge	Caliber	2W	A, B	35		65-61028
2011	2015	Dodge/Ram	Ram 1500	2W	G	5	OE Replacement 4-Flat	65-60013
2011	2015	Dodge/Ram	Ram 25/3500	2W	G	5	OE Replacement 4-Flat	65-60013
2011	2015	Dodge/Ram	Ram 1500	2W	G	5	Adds 4-Flat to OE 7-Way	65-60012

T-CONNECTORS

APPLICATIONS (CONTINUED)

START	END	MAKE	MODEL	ELECTRIC SYSTEM TYPE	WIRING LOCATION	INSTALL TIME (MIN)	NOTES	PART #
2011	2015	Dodge/Ram	Ram 25/3500	2W	G	5		65-60012
2011	2013	Dodge/Ram	Durango	2W	A, B	35		65-61028
2011	2014	Ford	Edge	3W	A, B	35		65-62057
2010	2015	Ford	Taurus	3W	C, D	15	Including SHO	65-62068
1980	1986	Ford	Bronco	2W	F	5		65-62002
1997	2015	Ford	F-150	2W	G	5	OE Replacement 4-Flat	65-60013
2000	2016	Ford	F-150 SuperCrew	2W	G	5	OE Replacement 4-Flat	65-60013
1999	2016	Ford	F-250/350	2W	G	5	OE Replacement 4-Flat	65-60013
1997	2016	Ford	F-150	2W	F	5		65-60012
2000	2016	Ford	F-150 SuperCrew	2W	F	5		65-60012
1999	2016	Ford	F-250/350	2W	F	5		65-60012
1980	1986	Ford	F-150	2W	E	5	Old Body	65-62002
1980	1986	Ford	F-250	2W	E	5		65-62002
1980	1986	Ford	F-350	2W	E	5		65-62002
1992	1994	Ford	Econoline	3W	A, B	15		65-62005
1987	1996	Ford	F-150	2W	E	5		65-62003
1987	1996	Ford	F-250	2W	E	5		65-62003
1987	1996	Ford	F-350	2W	E	5		65-62003
1997	1997	Ford	F-250HD	2W	E	5		65-62003
1997	1997	Ford	F-350HD	2W	E	5		65-62003
1992	1997	Ford	LTD / Country Squire	2W	C, D	10		65-62161
1992	1997	Ford	Crown Victoria	2W	C, D	10		65-62161
1997	1999	Ford	Escort	2W	A, B	10		65-62004
1997	2015	Ford	Expedition	2W	G	5	OE Replacement 4-Flat	65-60013
1997	2015	Ford	Expedition	2W	F	5		65-60012
1997	1999	Ford	Expedition	2W	C	5	OE Replacement 4-Flat	65-62014
1993	1999	Ford	Ranger	3W	E	5		65-62023
2000	2015	Ford	Explorer	2W	G	5	OE Replacement 4-Flat	65-60013
2000	2015	Ford	Explorer	2W	F	5		65-60012
1995	2000	Ford	Explorer	3W	A, B	30		65-62042
1995	2000	Ford	Explorer Sport	3W	A, B	30		65-62042
2001	2001	Ford	Explorer 4 Dr.	3W	A, B	30		65-62042
2000	2002	Ford	Expedition	2W	C	5	OE Replacement 4-Flat	65-62015
1995	2003	Ford	Econoline	2W	A, B	10		65-62004
1998	2003	Ford	Escort ZX2	2W	A, B	10		65-62004
1997	2003	Ford	Expedition	2W	A, B	10		65-62004
2002	2003	Ford	Explorer	2W	1,2	10		65-62004
2001	2003	Ford	Explorer Sport	2W	A, B	10		65-62004
2009	2015	Ford	Flex	2W	G	5	OE Replacement 4-Flat	65-60013
2009	2015	Ford	Flex	2W	F	5		65-60012
1997	2003	Ford	F150	2W	E	5	Flareside Only (New Body)	65-62004
1997	2003	Ford	F250LD	2W	E	5	Flareside Only	65-62004
2000	2003	Ford	Focus Wagon	2W	A, B	10	Vehicles built before 11/2002	65-62004
2000	2003	Ford	Ranger	2W	A, B	10		65-62004
2000	2003	Ford	Escape	3W	A, B	10		65-62005
1997	2003	Ford	F150 Heritage Edition	2W	E	5	OE Replacement 4-Flat	65-62007
1997	2003	Ford	F150LD	2W	E	5	OE Replacement 4-Flat (New Body)	65-62007
1997	2003	Ford	F250LD	2W	E	5	OE Replacement 4-Flat	65-62007
1999	2003	Ford	Windstar	3W	A, B	30	Vehicles built before 11/2002	65-62053
2003	2003	Ford	Windstar	3W	A, B	30	Vehicles built after 11/2002	65-62054
2000	2003	Ford	Taurus	2W	C, D	10	Sedan only	65-62064
2001	2004	Ford	Escape	2W	F	5	OE Replacement 4-Flat	65-62006
1994	2004	Ford	Mustang	2W	C, D	10		65-62161
2002	2005	Ford	Explorer	2W	C	5	OE Replacement 4-Flat	65-62044
2005	2007	Ford	F150	2W	G	5		65-62017
2005	2007	Ford	Escape	3W	A, B	30		65-62045
2004	2007	Ford	Freestar	2W	A, B	35		65-62055
2005	2007	Ford	Five Hundred	2W	A, B	10		65-62056
2005	2007	Ford	Freestyle	2W	A, B	10		65-62056
2005	2008	Ford	F250 / F350 Super Duty	2W	G	5		65-62018
2008	2009	Ford	Taurus	2W	A, B	10		65-62066
2007	2010	Ford	Edge	2W	A, B	35		65-62055
2010	2012	Ford	Transit Connect	3W	A, B	35		65-62049
2008	2012	Ford	Escape	2W	A, B	10		65-62055
2008	2012	Ford	Escape	2W	A, B	10	Vehicle with OE Tow Package w/o Backup Sensors	65-62059

START	END	MAKE	MODEL	ELECTRIC SYSTEM TYPE	WIRING LOCATION	INSTALL TIME (MIN)	NOTES	PART #
2006	2012	Ford	Fusion	2W	C, D	30		65-62065
2004	2014	Ford	Econoline	2W	A, B	10		65-62016
2011	2015	Ford	Explorer	3W	C, D	35	Powered Converter	65-62068
2009	2014	Ford	Flex	2W	A, B	15		65-62048
2011	2014	Ford	Fiesta Sedan	2W	A, B	35		65-62065
2013	2016	Ford	Escape	3W	A, B	35		65-62076
2012	2016	Ford	Focus Sedan	3W	C, D	35		65-62080
2012	2015	Ford	Focus Hatchback	3W	A, B	35		65-62081
2011	2014	Ford	Fiesta Hatchback	3W	C, D	35		65-62172
1986	1992	Ford	Ranger Pickups	3W	E	10		65-62021
1973	1979	Ford	F-Series Pickups	3W	G	5		65-62001
2011	2016	Honda	Odyssey	3W	C	20		65-63116
2012	2016	Honda	CR-V	3W	C	20		65-63120
2006	2014	Honda	Ridgeline	3W	A, B	10		65-63150
1994	2002	Honda	Accord Coupe	3W	C	5		65-63101
1994	2002	Honda	Accord Sedan	3W	C	5		65-63101
2001	2002	Honda	Prelude	3W	C, D	5		65-63101
2003	2004	Honda	Element	3W	C	5		65-63101
1995	2004	Honda	Odyssey	3W	C	5		65-63101
2001	2005	Honda	Civic Sedan (Except Hybrid)	3W	C, D	10		65-63113
2003	2005	Honda	Accord Coupe	3W	C, D	10		65-63114
2004	2005	Honda	Civic Coupe (Except SI Models)	3W	C, D	10		65-63114
1997	2006	Honda	CR-V	3W	C	5		65-63101
2003	2007	Honda	Accord Sedan	3W	C, D	5		65-63102
2006	2007	Honda	Accord Coupe	3W	A, B	15		65-63103
2003	2008	Honda	Pilot	3W	C, D	5		65-63101
2005	2010	Honda	Odyssey	3W	D	20		65-63107
2007	2011	Honda	CR-V	3W	C, D	20		65-63106
2009	2011	Honda	Pilot	3W	C & F	20	Converter plugs in behind driver's side cargo panel and 7-Way plugs in under bumper, center of vehicle	65-63112
2008	2012	Honda	Accord Coupe	3W	C, D	10		65-63104
2008	2012	Honda	Accord Sedan	3W	C, D	10		65-63104
2007	2012	Honda	Element	3W	—	20	Converter plugs in under dash and 4-Flat plugs in center of spare tire area.	65-63108
2010	2012	Honda	Crosstour	3W	D	10		65-63110
2006	2015	Honda	Civic Sedan (Except Hybrid)	3W	C, D	10		65-63104
2007	2013	Honda	Fit	3W	C, D	10		65-63104
2003	2009	Hummer	H2	2W	F	5		65-60012
2005	2009	Hummer	H2 SUT	2W	F	5		65-60012
2006	2010	Hummer	H3	2W	F	5	Adds 4-Flat to OE 7-Way	65-60012
2009	2010	Hummer	H3T	2W	F	5		65-60012
2007	2009	Hyundai	Entourage	3W	C, D	10		65-66012
2005	2009	Hyundai	Tucson	3W	C, D	15		65-66210
2006	2009	Hyundai	Sonata	3W	C, D	10		65-66251
2007	2010	Hyundai	Elantra Sedan	3W	C, D	10		65-66251
2006	2011	Hyundai	Azera	3W	C, D	35		65-65132
2007	2012	Hyundai	Santa Fe	3W	C, D	10	Powered Converter	65-66033
2007	2012	Hyundai	Santa Fe	3W	E	10	OE Replacement 4-Flat	65-66202
2007	2012	Hyundai	Veracruz	3W	E	10		65-66211
2009	2012	Hyundai	Genesis Sedan	3W	C, D	15		65-66250
2010	2012	Hyundai	Genesis Coupe	3W	C, D	15		65-66252
2010	2013	Hyundai	Tucson	3W	A, B	35		65-66212
2011	2013	Hyundai	Elantra Sedan	3W	C, D	15	Sedan 2011-2013 / Coupe 2013	65-66253
2013	2014	Hyundai	Elantra Coupe	3W	C, D	15	Sedan 2011-2013 / Coupe 2013	65-66253
1997	2003	Infiniti	QX4	3W	A, B	20		65-64002
2007	2008	Infiniti	G35	3W	C, D	35		65-64150
2004	2012	Infiniti	QX56	2W	F	5	Adds 4-Flat to OE 7-Way	65-60012
2009	2013	Infiniti	G37	3W	C, D	35		65-64150
1996	1999	Isuzu	Oasis	3W	C	10		65-63101
1998	2000	Isuzu	Hombre	2W	E	5		65-60021
2003	2008	Isuzu	Ascender	2W	F	5		65-60012
2006	2008	Isuzu	I-280, I-350	3W	E	10		65-60022
2007	2008	Isuzu	I-290, I-370	3W	E	10		65-60022
2011	2015	Jeep	Grand Cherokee	2W	F	5		65-60012
2008	2016	Jeep	Patriot	2W	A, B	35		65-61028
2007	2016	Jeep	Wrangler	2W	A	10		65-61124

T-CONNECTORS

APPLICATIONS (CONTINUED)

START	END	MAKE	MODEL	ELECTRIC SYSTEM TYPE	WIRING LOCATION	INSTALL TIME (MIN)	NOTES	PART #
1991	1995	Jeep	Wrangler	2W	E, G	10		65-61121
1997	1997	Jeep	Wrangler	2W	E, G	10		65-61121
1999	2004	Jeep	Grand Cherokee	3W	C	10		65-61114
2005	2006	Jeep	Grand Cherokee	3W	C, D	10		65-61115
1998	2006	Jeep	Wrangler	2W	E, G	10		65-61123
1998	2006	Jeep	Wrangler TJ (Canada)	2W	E, G	10		65-61123
2004	2006	Jeep	Wrangler Unlimited	2W	E, G	10		65-61123
2007	2007	Jeep	Patriot	3W	C, D	45		65-61050
2002	2007	Jeep	Liberty	3W	A, B	10		65-61104
2005	2008	Jeep	Liberty	2W	E	5		65-61003
2007	2009	Jeep	Wrangler Unlimited	2W	A	10		65-61124
2006	2010	Jeep	Commander	2W	E	5		65-61003
2000	2010	Jeep	Grand Cherokee	2W	E	5	Adds 4-Flat to OE 7-Way	65-61003
2007	2010	Jeep	Compass	3W	A, B	45		65-61050
2006	2010	Jeep	Commander	3W	C, D	15		65-61116
2009	2012	Jeep	Liberty	2W	F	5		65-60012
2008	2012	Jeep	Liberty	3W	A, B	15		65-61027
2007	2013	Jeep	Grand Cherokee	2W	A, B	10		65-61117
2010	2016	Kia	Soul	3W	A, B	15		65-66003
2014	2014	Kia	Sedona	3W	C, D	10		65-66012
2007	2009	Kia	Sorento 6 Cylinder w/ Tow Package	3W	G	5		65-66211
2007	2010	Kia	Rondo LX	3W	A, B	15		65-66003
2009	2010	Kia	Optima	3W	C, D	10		65-66251
2009	2011	Kia	Borrego	2W	F	10		65-60012
2006	2012	Kia	Sedona	3W	C, D	10		65-66012
2011	2013	Kia	Sorento 4 Cylinder & 6 Cylinder w/o Tow Package	3W	A, B	35	Except SX models	65-66004
2010	2013	Kia	Forte Sedan	3W	C, D	20		65-66033
2011	2014	Kia	Sorento 6 Cylinder w/ Tow Package	3W	G	5		65-66211
2001	2003	Lexus	RX 300	2W	E	10	OE Replacement 4-Flat	65-65131
2003	2006	Lexus	RX 330	3W	C	45		65-65141
2001	2007	Lexus	LX 470	2W	E	10	OE Replacement 4-Flat	65-65131
2006	2010	Lexus	RX 400h	3W	C, D	45		65-65143
2010	2015	Lexus	GX 460	2W	G	5	OE Replacement 4-Flat	65-60013
2010	2015	Lexus	GX 460	2W	F	5		65-60012
2007	2011	Lexus	ES 350	3W	C, D	45		65-65430
2007	2012	Lexus	RX 350	3W	C	45		65-65141
2010	2012	Lexus	RX 350	2W	F	5	w/ Factory tow harness	65-65142
2010	2012	Lexus	RX 450h	2W	F	5	w/ Factory tow harness	65-65142
2011	2015	Lincoln	MKX	2W	A, B	35		65-62058
1998	2015	Lincoln	Navigator	2W	G	5	OE Replacement 4-Flat	65-60013
1998	2015	Lincoln	Navigator	2W	F	5		65-60012
1997	1999	Lincoln	Navigator	2W	C	5	OE Replacement 4-Flat	65-62014
2000	2002	Lincoln	Navigator	2W	C	5		65-62015
1998	2003	Lincoln	Navigator	2W	A, B	10	OE Replacement 4-Flat	65-62004
2003	2004	Lincoln	Aviator	2W	A, B	10		65-62004
2007	2009	Lincoln	MKX	2W	A, B	35		65-62055
2009	2012	Lincoln	MKS	3W	C, D	10		65-62172
2010	2015	Lincoln	MKT	2W	G	5	OE Replacement 4-Flat	65-60013
2010	2015	Lincoln	MKT	2W	F	5		65-60012
2010	2013	Lincoln	MKT	2W	A, B	35		65-62173
2013	2015	Lincoln	MKS	3W	C, D	10		65-62068
2001	2004	Mazda	Tribute	3W	A, B	10		65-62005
2001	2004	Mazda	Tribute	2W	F	5	OE Replacement 4-Flat	65-62006
2001	2004	Mazda	Tribute	3W	A, B	10		65-62042
2005	2006	Mazda	Tribute	3W	A, B	30		65-62045
2000	2006	Mazda	MPV	3W	C, D	20		65-62050
1994	2008	Mazda	B-Series	3W	E	5		65-62023
2003	2008	Mazda	6	3W	C, D	30		65-62200
2008	2011	Mazda	Tribute	2W	A, B	10		65-62055
2007	2012	Mazda	CX-9	3W	C, D	30		65-62070
2007	2012	Mazda	CX-7 w/o Tow Package	3W	C, D	30	Powered Converter	65-62200
2007	2012	Mazda	CX-7 w/ Tow Package	3W	D	20		65-62300
2011	2013	Mazda	2	3W	C, D	30		65-62070
2006	2015	Mazda	5	3W	C, D	30		65-62070
2009	2013	Mazda	6	3W	C, D	40		65-62201

T-CONNECTOR APPLICATIONS

START	END	MAKE	MODEL	ELECTRIC SYSTEM TYPE	WIRING LOCATION	INSTALL TIME (MIN)	NOTES	PART #
2014	2015	Mazda	3	3W	C, D	30		65-62200
2004	2013	Mazda	3	3W	C, D	10		65-63104
1992	1997	Mercury	Grand Marquis	2W	C, D	10		65-62161
1998	1998	Mercury	Villager	3W	F	5		65-64201
1997	1999	Mercury	Tracer	2W	A, B	10		65-62004
1996	1999	Mercury	Sable Wagon	3W	A, B	10		65-62005
1997	2001	Mercury	Mountaineer	3W	A, B	30		65-62042
2002	2003	Mercury	Mountaineer	2W	A, B	10		65-62004
2000	2003	Mercury	Sable Sedan	2W	C, D	10		65-62064
2002	2004	Mercury	Mountaineer	2W	C	5	OE Replacement 4-Flat	65-62044
2004	2007	Mercury	Monterey	2W	A, B	45		65-62055
2008	2009	Mercury	Sable Sedan	2W	C, D	10		65-62066
2008	2011	Mercury	Mariner	2W	A, B	45		65-62055
2014	2016	Mitsubishi	Outlander	3W	C, D	40		65-65416
2011	2014	Mitsubishi	Outlander Sport	3W	A, B	35		65-66123
2001	2006	Mitsubishi	Montero	3W	A, B	20		65-66102
2006	2009	Mitsubishi	Raider	2W	C, D	35		65-61022
2003	2011	Mitsubishi	Endeavor	3W	A, B	30		65-66103
2007	2012	Mitsubishi	Galant	3W	C, D	10		65-63104
2007	2013	Mitsubishi	Outlander	3W	C, D	35	OE Replacement 4-Flat	65-66122
2005	2016	Nissan	Frontier	2W	E	5		65-64004
2005	2013	Nissan	Xterra	2W	A, B	5	OE Replacement 4-Flat	65-64004
2009	2014	Nissan	Murano	3W	C, D	20	Exc CrossCabriolet	65-64106
2008	2016	Nissan	Rogue	3W	C, D	40		65-64150
2007	2015	Nissan	Altima Sedan	3W	C, D	20		65-64300
2004	2014	Nissan	Maxima	3W	C, D	20		65-64300
1998	1998	Nissan	Quest	3W	F	5		65-64201
1998	2001	Nissan	Altima Sedan	3W	C, D	10	Adds 4-Flat to OE 7-Way	65-64002
1996	2004	Nissan	Pathfinder	3W	C, D	20		65-64002
1998	2004	Nissan	Frontier	3W	F	5		65-64201
2003	2005	Nissan	Murano	3W	C, D	20		65-64106
2006	2008	Nissan	Murano	PWM	C, D	20		65-64107
2004	2009	Nissan	Quest	3W	C, D	30		65-64202
2005	2010	Nissan	Pathfinder	2W	C, D	5	OE Replacement 4-Flat	65-64004
2007	2012	Nissan	Versa (Sedan & Hatchback)	3W	C, D	30		65-64005
2007	2012	Nissan	Sentra	3W	C, D	20		65-64300
2004	2015	Nissan	Armada	2W	G	5	OE Replacement 4-Flat	65-60013
2004	2015	Nissan	Titan	2W	G	5	OE Replacement 4-Flat	65-60013
2004	2015	Nissan	Armada	2W	F	5		65-60012
2004	2015	Nissan	Titan	2W	F	5	Adds 4-Flat to OE 7-Way	65-60012
2008	2013	Nissan	Altima Coupe	3W	C, D	20		65-64300
1999	2004	Oldsmobile	Bravada	2W	F	5	Adds 4-Flat to OE 7-Way	65-60012
1997	2005	Oldsmobile	Silhouette	3W	C	10		65-60052
1988	1990	Plymouth	Voyager & Grand Voyager	2W	A, B	10		65-61021
1986	1993	Plymouth	Trailduster	2W	E, F	5		65-61001
1991	1995	Plymouth	Voyager & Grand Voyager	2W	A, B	20		65-61022
1996	2000	Plymouth	Voyager & Grand Voyager	3W	A, B	20		65-61023
2001	2003	Plymouth	Voyager & Grand Voyager	3W	A	10		65-61024
2004	2004	Plymouth	Voyager & Grand Voyager	2W	A, B	10		65-61025
1999	2005	Pontiac	Montana	3W	C	10		65-60052
1997	2005	Pontiac	Trans Sport	3W	C	10		65-60052
2001	2005	Pontiac	Aztek	2W	A, B	20		65-60053
2006	2006	Pontiac	Torrent	2W	A, B	10		65-60037
2005	2006	Pontiac	Montana SV6	2W	C	5		65-60056
2007	2009	Pontiac	Torrent	3W	C	10		65-60038
2007	2009	Pontiac	G5 2 Dr.	2W	A, B	10		65-60039
2005	2009	Pontiac	Pursuit 2 Dr. (Canada Only)	2W	A, B	10		65-60039
2005	2009	Pontiac	Pursuit Gt 2 Dr.(Canada Only)	2W	A, B	10		65-60039
2007	2009	Pontiac	G5 4 Dr.	2W	A, B	10		65-60060
2005	2009	Pontiac	Pursuit 4 Dr.(Canada Only)	2W	A, B	10		65-60060
2005	2009	Pontiac	Pursuit Gt 4 Dr.(Canada Only)	2W	A, B	10		65-60060
2005	2009	Pontiac	G6	2W	C, D	5		65-60065
2007	2010	Pontiac	G5 GT 2 Dr.	2W	A, B	10		65-60039
2009	2010	Pontiac	Vibe	3W	C, D	40		65-60058
2012	2016	Ram	C/V Tradesman	2W	A, B	35		65-61029
2005	2009	Saab	9-7X	2W	F	5		65-60012

T-CONNECTORS

APPLICATIONS (CONTINUED)

START	END	MAKE	MODEL	ELECTRIC SYSTEM TYPE	WIRING LOCATION	INSTALL TIME (MIN)	NOTES	PART #
2002	2007	Saturn	Vue	3W	A, B	20		65-60035
2004	2007	Saturn	Vue Red Line	3W	A, B	20		65-60035
2005	2007	Saturn	Relay	2W	C	5		65-60056
2007	2009	Saturn	Outlook	2W	F	5	Adds 4-Flat to OE 7-Way	65-60012
2007	2009	Saturn	Aura	3W	C, D	10		65-60063
2007	2009	Saturn	Outlook	2W	A, B	15		65-60070
2008	2009	Saturn	Vue	3W	A, B	35		65-60071
2008	2009	Saturn	Vue Red Line	3W	A, B	35		65-60071
2004	2007	Scion	xB	3W	C, D	20		65-65114
2008	2010	Scion	xB	3W	A, B	45		65-65115
2007	2010	Scion	tC	3W	C, D	35		65-65116
2011	2013	Scion	xB	3W	C, D	40		65-60058
2010	2016	Subaru	Outback	3W	C	15		65-66302
1996	1999	Subaru	Legacy	3W	C	10	Wagon Only	65-66301
2005	2007	Subaru	Legacy	3W	C	10		65-66301
1998	2008	Subaru	Forester	3W	D	10		65-66301
2000	2009	Subaru	Outback	3W	C	10	Wagon Only	65-66301
2006	2013	Subaru	B9 Tribeca	3W	D	10		65-66301
2009	2016	Subaru	Forester	3W	C	15		65-66302
2007	2009	Suzuki	XL7	3W	C	10		65-60038
2009	2011	Suzuki	Equator	2W	A, B	5		65-64004
2007	2011	Suzuki	SX-4	3W	C	20		65-66401
2006	2012	Suzuki	Grand Vitara	3W	C	20		65-66401
2010	2015	Toyota	Tacoma	3W	A, B	35		65-65005
2013	2015	Toyota	Avalon	3W	C, D	20		65-65117
2014	2016	Toyota	Corolla	3W	C, D	40		65-62200
2013	2015	Toyota	Rav4	3W	C, D	20		65-65117
2011	2015	Toyota	Sienna (SE 2015 Only)	3W	A, B	35		65-65203
2009	2015	Toyota	Venza	3W	C, D	40		65-65416
2008	2016	Toyota	Highlander	3W	C, D	20		65-65133
2010	2015	Toyota	4Runner	2W	G	5	OE Replacement 4-Flat	65-60013
2010	2015	Toyota	Tundra	2W	G	5	OE Replacement 4-Flat	65-60013
2010	2015	Toyota	4Runner	2W	F	5		65-60012
2010	2015	Toyota	Tundra	2W	F	5		65-60012
1989	1995	Toyota	Pickup	3W	A, B	10		65-65001
1993	1998	Toyota	T100	3W	E, F	10		65-65002
2001	2002	Toyota	Tundra	3W	E	10		65-65004
2001	2002	Toyota	4Runner w/ Tow Package	2W	E	10	OE Replacement 4-Flat	65-65131
2000	2002	Toyota	Landcruiser	2W	E	10	OE Replacement 4-Flat	65-65131
2001	2003	Toyota	Highlander	2W	E	10	OE Replacement 4-Flat	65-65131
1998	2003	Toyota	Sienna	3W	C, D	15		65-65201
2003	2003	Toyota	Corolla Sedan	3W	C, D	15		65-65421
1995.5	2004	Toyota	Tacoma	3W	A, B	10		65-65001
2001	2005	Toyota	Rav4	3W	C, D	15		65-65112
2001	2007	Toyota	Highlander	3W	C, D	20	Will not fit Hybrid model	65-65132
2004	2007	Toyota	Highlander w/ Tow Package	2W	C	15		65-65134
2007	2009	Toyota	Camry Sedan	3W	C, D	30	Except Hybrid Model	65-62200
2005	2009	Toyota	Tacoma	3W	A, B	10		65-65002
2004	2010	Toyota	Sienna	3W	A, B	15		65-65202
2004	2010	Toyota	Prius	3W	C, D	20		65-65418
2010	2011	Toyota	Camry Sedan	3W	C, D	40		65-65416
2007	2011	Toyota	Camry Sedan Hybrid	3W	C, D	40		65-65416
2006	2012	Toyota	Rav4	3W	C, D	20		65-65113
2011	2012	Toyota	Avalon	3W	C, D	40		65-65416
2009	2013	Toyota	Matrix	3W	C, D	40		65-60058
2012	2016	Toyota	Camry Sedan	3W	C, D	30	Except Hybrid Model	65-62200
2007	2013	Toyota	FJ Cruiser	3W	C, D	20		65-62200
2004	2013	Toyota	Corolla Sedan	3W	C, D	40		65-65422
2008	2010	Volvo	V70	3W	C, D	40		65-66566
2008	2010	Volvo	XC70	3W	C, D	40		65-66566
2005	2014	Volvo	XC90	3W	C, D	20		65-66565
2007	2015	Volvo	S80	3W	C, D	45		65-66567
2007	2015	Volkswagen	Touareg	2W	F	5		65-60012
2007	2015	Volkswagen	Touareg	2W	G	5	OE Replacement 4-Flat	65-60013

TAIL LIGHT CONVERTERS

SYSTEM TYPES

WHAT IS A TAIL LIGHT CONVERTER?

A tail light converter is an electronic device that will accept a 3-wire electrical signal from a tow vehicle and convert the signal to one that a 2-wire system of a trailer without damaging the electrical systems of either vehicle.

2-WIRE WIRING SYSTEMS

2-wire systems can be identified by use of a single bulb on each side of the vehicle/trailer to provide both stop lamp and turn signal illumination.

3-WAY WIRE SYSTEMS

3-wire systems utilize separate wires to provide power to the stop lamp and turn signal bulbs. 3-wire systems can be identified by twin bulbs in each side of the vehicle/trailer.

STANDARD 2-WIRE TO 3-WIRE SYSTEMS

- Moisture resistant overmolded enclosure
- Rated up to 7.5 amps tail light circuit
- 2.5 amps stop/turn per side
- For most incandescent/standard bulbs
- 100% stranded copper wire
- 24" 16 ga. input leads
- 24" 16 ga. output leads

65-75158

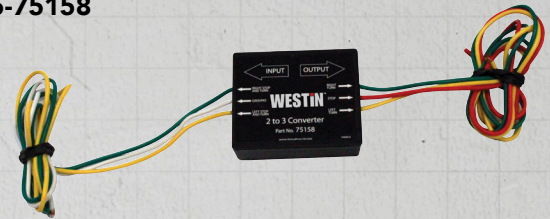

STANDARD 3-WIRE TO 2-WIRE SYSTEMS

- Moisture resistant overmolded enclosure
- Rated up to 7 amps tail light circuit
- 4.5 amps stop/turn per side
- For most incandescent/standard bulbs
- Includes marker/tail light wiring
- 18" 16 ga. input leads
- 60" 16 ga. bonded output wires
- 4-flat trailer connector
- Protective dust cap

65-75330

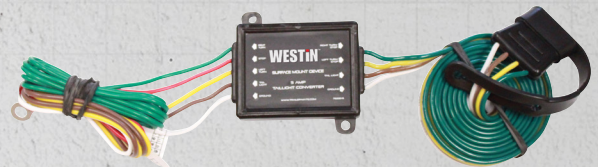

STANDARD 2-WIRE TO 3-WIRE SYSTEMS

- Moisture resistant overmolded enclosure
- Rated up to 7.5 amps tail light circuit
- 2.5 amps stop/turn per side
- For most incandescent/standard bulbs
- 100% stranded copper wire
- Includes marker/tail light wiring
- 18" 16 ga. input leads
- 60" 16 ga. bonded output wires
- 4-flat trailer connector
- Protective dust cap

65-75375

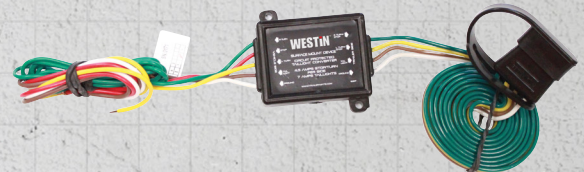

ADVANCED BATTERY PROTECTION

- Vehicle PWM input compatible
- Moisture resistant overmolded enclosure
- 5 amps stop/turn per side
- 10 amps tail light circuit
- For most incandescent/standard bulbs/LEDs
- Includes marker/tail light wiring
- 12" 16 ga. input leads
- 60" 16 ga. bonded output wires
- 4-flat trailer connector
- Protective dust cap

65-75390

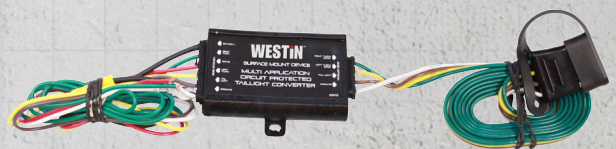

Note: Refer to page 4-11 for ST & STT system vehicle applications

CONNECTORS

ELECTRICAL

Designed and developed to provide multiple connector functionality. Options include 7-Way, 6-Way and 4-Flat vehicle-side connectors, and LED lighting. Sealed housings & OEM-Quality connectors.

7-WAY CONNECTOR WIRING		6-WAY CONNECTOR WIRING	
The diagram below illustrates the standard wiring pattern for 7-way connectors.		The diagram below illustrates the most popular wiring pattern for 6-way connectors.	
TRAILER SIDE	VEHICLE SIDE	TRAILER SIDE	VEHICLE SIDE
A Electric Brakes	A Electric Brakes	A Left Turn	A Right Turn
B Ground	B Ground	B Right Turn	B Left Turn
C Left Turn/Stop	C Left Turn/Stop	C Electric Brakes	C Ground
D Tailights	D Tailights	D Tailights	D Tailights
E 12V	E 12V	E Ground	E Electric Brakes
F Right Turn/Stop	F Right Turn/Stop	F 12V	F 12V
G Auxiliary	G Auxiliary	G Screw Hole	G Screw Hole

COMBO CONNECTOR FEATURES

- Weather resistant
- Encapsulated terminals and wires
- 100% copper stranded wire
- Flat brass terminals
- Engineered & manufactured to SAE standards
- Spring loaded connector door repels moisture when not in use
- 30 Amp max load
- Environmental and load tested

7-WAY/4-FLAT TO 7-WAY
Ford & GM Applications

65-75119

- One piece molded design
- Plugs directly into vehicle wiring harness*
- Additional 4-flat connector allows for convenient multiple trailer use

4 TO 7

MATING CONNECTOR

65-75021

MOUNTING BRACKET INCLUDED

(2) 4-FLAT TO 7-WAY
Universal 4-FLAT Input

65-75144

- One piece molded design
- Pre-wired 7-way & 4-flat combo-connector
- Additional 4-flat connector allows for convenient multiple trailer use

4 TO 7

MATING CONNECTOR

65-75021

MOUNTING BRACKET INCLUDED

(2) 4-FLAT TO 6-WAY
Universal 4-FLAT Input

65-75143

- 4-flat trailer side connector quickly plugs into a T-Connector or other existing 4-way
- One piece molded design
- Additional 4-flat connector allows for convenient multiple trailer use

4 TO 6

MATING CONNECTOR

65-75037

MOUNTING BRACKET INCLUDED

* Where equipped

CONNECTORS

VEHICLE-SIDE

4-WAY ROUND CONNECTOR WIRING

The diagram below illustrates the most common wiring pattern for 4-way connectors.

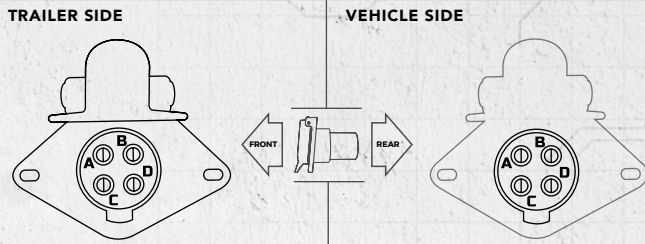

A	Left Turn/Stop	A	Ground
B	Ground	B	Left Turn/Stop
C	Tailights	C	Tailights
D	Right Turn/Stop	D	Right Turn/Stop

4-FLAT CONNECTOR WIRING STANDARD

The diagram below illustrates the proper wiring pattern for both car and trailer-side 4-way flat connectors.

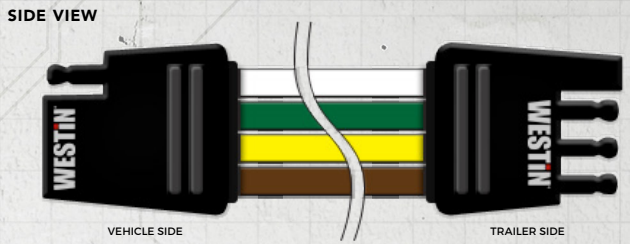

WHITE	Ground
BROWN	Marker Lights
YELLOW	Left Turn Signal / Stop Lamps
GREEN	Right Turn Signal / Stop Lamps

4-WAY ROUND

Durable Die-Cast Metal Chassis

65-75201



- Designed for use with light-duty camper & utility trailer applications
- 7.5 amp max load

MATING CONNECTOR



65-75202

MOUNTING BRACKET



65-75471

6-WAY ROUND

Durable Die-Cast Metal Chassis

65-75036

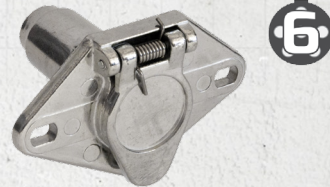

- Designed for use with agricultural, stock, tool & heavy equipment trailer applications
- 30 amp max load

MATING CONNECTOR



65-75037

MOUNTING BRACKET



65-75471

7-WAY ROUND (RV STYLE)

Plastic Housing w/Sealed Door

65-75300



- Designed for use with RV and Heavier Utility & Equipment trailers equipped with electric brakes
- 30 amp max load

MATING CONNECTOR



65-75021

MOUNTING BRACKET



65-75473

7-WAY ROUND

OEM Replacement Connector*

65-75015



- Designed for use with RV and Heavier Utility & Equipment trailers equipped with electric brakes
- 30 amp max load

MATING CONNECTOR



65-75021

MOUNTING BRACKET



65-75474

7-WAY ROUND

Twist-Lock OEM Replacement Connector*

65-75047

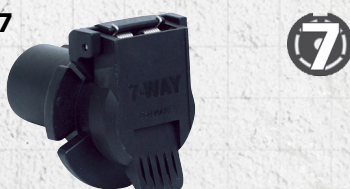

- Designed for use with RV and Heavier Utility & Equipment trailers equipped with electric brakes
- 30 amp max load

MATING CONNECTOR



65-75021

MOUNTING BRACKET NOT REQUIRED



65-75473

4-WAY FLAT

Vehicle Side (Available in 48" and 60")

48" - 65-75036

60" - 65-75002

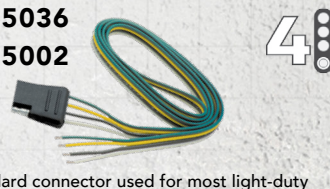

- Industry standard connector used for most light-duty applications. Including RV, Marine & Utility Trailers where electric brakes or other additional power demands are not required.
- 7.5 amp max load

MATING CONNECTOR



65-75004

MOUNTING BRACKET







65-75470

* Direct replacement for factory 7-way connectors on most Buick, Cadillac, Chevrolet, GMC, Hummer and Oldsmobile vehicles equipped with trailer tow package wiring.



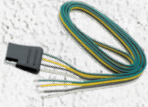









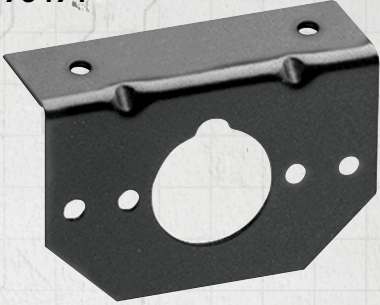

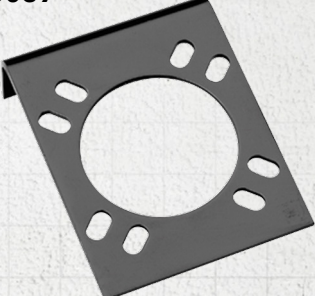

CONNECTORS

TRAILER-SIDE

<p>7-WAY ROUND Plastic Housing Resists Corrosion</p> <p>65-75021</p>  <ul style="list-style-type: none"> Designed for use with RV and Heavier Utility & Equipment trailers equipped with electric brakes 30 amp max load 	<p>MATING CONNECTOR</p>  <p>65-75300</p>  <p>65-75015</p>	<p>6-WAY ROUND Durable Die-Cast Metal Chassis</p> <p>65-75037</p>  <ul style="list-style-type: none"> Designed for use with agricultural, stock, tool & heavy equipment trailer applications 30 amp max load 	<p>MATING CONNECTOR</p>  <p>65-75036</p> <p>MOUNTING BRACKET NOT REQUIRED</p>
<p>4-WAY ROUND Durable Die-Cast Metal Chassis</p> <p>65-75202</p>  <ul style="list-style-type: none"> Designed for use with Light-Duty Camper & Utility trailer applications 7.5 amp max load 	<p>MATING CONNECTOR</p>  <p>65-75201</p> <p>MOUNTING BRACKET NOT REQUIRED</p>	<p>4-WAY FLAT 12" Harness</p> <p>12" - 65-75004</p>  <ul style="list-style-type: none"> Industry standard connector used for most light-duty applications. Including RV, Marine & Utility Trailers where electric brakes or other additional power demands are not required. 7.5 amp max load 	<p>MATING CONNECTOR</p>  <p>48" - 65-75036 60" - 65-75002</p> <p>MOUNTING BRACKET NOT REQUIRED</p>
<p>4-WAY FLAT EXTENDER (RV STYLE) Flexible Molded PVC Connectors (Available in 18", 48" and 60")</p> <p>18" - 65-75185 48" - 65-75044 60" - 65-75045</p>  <ul style="list-style-type: none"> Industry standard connector used for most light-duty applications. Including RV, Marine & Utility Trailers where electric brakes or other additional power demands are not required. 7.5 amp max load 		<p>MATING CONNECTOR</p>  <p>48" - 65-75036 60" - 65-75002</p>  <p>12" - 65-75112</p>	
<p>4-WAY FLAT Protective Cover</p> <p>W/O LED - 65-75112 W/ LED - 65-75904</p>  <ul style="list-style-type: none"> Built-in tether retains cover when not in use Helps to prevent rust & corrosion Manufactured from black PVC rubber 		<p>MATING CONNECTOR</p>  <p>48" - 65-75036 60" - 65-75002</p>  <p>12" - 65-75112</p>	

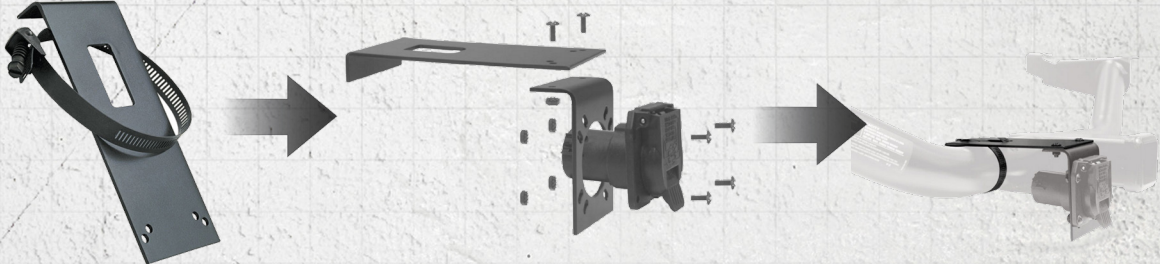
MOUNTING BRACKETS

FOR CONNECTORS

<p>4-WAY FLAT Connector Mounting Bracket</p> <p>65-75021</p>  <ul style="list-style-type: none"> Mounts common 4-flat wiring connectors to rear of tow vehicle Convenient "Push-In" connector mounting Black powdercoat finish 	<p>COMPANION BRACKET</p>  <p>65-75476</p> <p>APPLICABLE CONNECTOR</p>  <p>48" - 65-75036 60" - 65-75002</p>	<p>4, 5 & 6 WAY ROUND Connector Mounting Bracket</p> <p>65-75471</p>  <ul style="list-style-type: none"> Mounts common 4, 5 & 6-Way round wiring connectors to rear of tow vehicle Bolt-on connector mounting Black powdercoat finish 	<p>COMPANION BRACKET</p>  <p>65-75476</p> <p>APPLICABLE CONNECTOR</p>  <p>65-75036</p>  <p>65-75201</p>
<p>7-WAY (OEM STYLE) Connector Mounting Bracket</p> <p>65-75473</p>  <ul style="list-style-type: none"> Mounts common 7-way RV-style connectors to rear of tow vehicle Bolt-on connector mounting Black powdercoat finish 	<p>COMPANION BRACKET</p>  <p>65-75476</p> <p>APPLICABLE CONNECTOR</p>  <p>65-75300</p>	<p>7-WAY (OEM STYLE) Connector Mounting Bracket</p> <p>65-75037</p>  <ul style="list-style-type: none"> Universal design - Mounts either US car or RV-style 7-way wiring connectors to rear of tow vehicle Bolt-on connector mounting Black powdercoat finish 	<p>COMPANION BRACKET</p>  <p>65-75476</p> <p>APPLICABLE CONNECTOR</p>  <p>65-75300</p>  <p>65-75015</p>
<p>6 & 7-WAY ROUND (LONG BRACKET) Attachment Bracket W/Clamp For Mounting</p> <p>65-75476</p>  <ul style="list-style-type: none"> Attaches electrical connector mounting bracket to trailer hitch cross tube No cutting, welding or drilling Hose clamp mounting Black powdercoat finish 			<p>COMPANION BRACKET</p>  <p>65-75471</p>  <p>65-75473</p>  <p>65-75474</p>

ADAPTERS

ELECTRICAL

Available in the new automotive standard as well as RV flat pin and traditional automotive round pin designs in both vehicle-side and trailer-side configurations.

ADAPTER FEATURES

- Designed to replace OEM parts
- Moisture proof housings
- Flat brass terminals
- Engineered & manufactured to SAE standards
- Environmental and load tested

7-WAY TO 6-WAY ADAPTER WIRING

The diagram below illustrates the wiring pattern this adapter

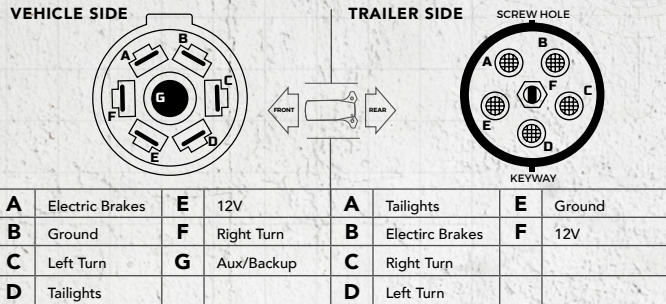

7-WAY TO 4-FLAT ADAPTER WIRING

The diagram below illustrates the wiring pattern this adapter

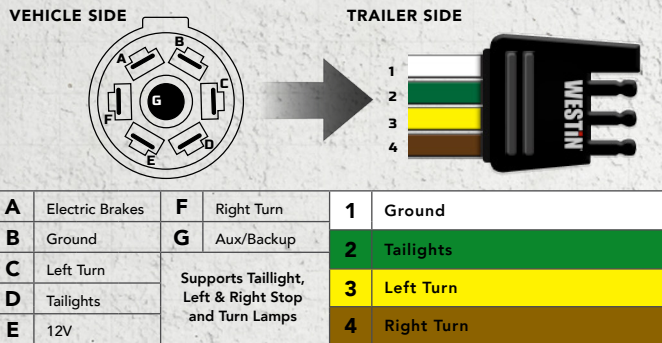

7-WAY TO 5-FLAT ADAPTER WIRING

The diagram below illustrates the wiring pattern this adapter

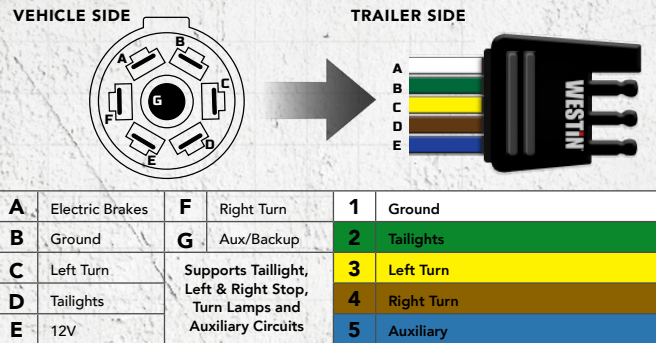

7-WAY (RV STYLE) TO 4-FLAT Trailer Wiring Adapter

65-75702



- Trailer wiring adapters are ideal for situations where a single vehicle tows more than one trailer
- 7.5 amp max load

MATING CONNECTOR



65-75015

7-WAY (RV STYLE) TO 5-FLAT Trailer Wiring Adapter

65-75703



- Trailer wiring adapters are ideal for situations where a single vehicle tows more than one trailer
- 7.5 amp max load

MATING CONNECTOR



65-75015

ADAPTERS

VEHICLE/TRAILER SIDE

7-WAY (RV STYLE) TO 6-WAY
Trailer Wiring Adapter (Brakes to Outer Pin)

65-75704

- Trailer wiring adapters are ideal for situations where a single vehicle tows more than one trailer
- 30 amp max load

MATING CONNECTOR
65-75015

7-WAY (RV STYLE) TO 4-FLAT W/ LED PROTECTION COVER
Trailer Wiring Adapter

65-75707

- Trailer wiring adapters are ideal for situations where a single vehicle tows more than one trailer
- Includes LED cover test tail light, left & right stop and turn circuit
- 7.5 amp max load

MATING CONNECTOR
65-75015
12" - 65-75112

7-WAY (RV STYLE) TO 6-WAY
Trailer Wiring Adapter (Brakes to Center Pin)

65-75708

- Trailer wiring adapters are ideal for situations where a single vehicle tows more than one trailer
- 30 amp max load

MATING CONNECTOR
65-75015
65-75037

7-WAY (RV STYLE) TO 5-WAY FLAT
Coiled Adapter Harness (Flex Cable)

65-75075

- Extends to 5'
- Works with both RV and USCar style 7-way connectors
- 7.5 amp max load

MATING CONNECTOR
65-75015
MOUNTING BRACKET NOT REQUIRED

7-WAY (RV STYLE) TO 4-WAY FLAT
Coiled Adapter Harness (Flex Cable)

65-75065

- Extends to 5'
- Works with both RV and USCar style 7-way connectors
- 7.5 amp max load

MATING CONNECTOR
65-75015
MOUNTING BRACKET NOT REQUIRED

BRAKE CONTROLLERS

TRAILER BRAKE PRODUCTS

TIME ACTUATED LED CONTROL ELECTRIC TRAILER BRAKE CONTROL WITH LED DISPLAY

65-75510

W⁴
SIGNATURE OF QUALITY

SERIES



TIME ACTUATED DIGITAL CONTROL DIGITAL TRAILER BRAKE CONTROL FOR 1 TO 4 AXLE TRAILERS

65-75520

W⁶
SIGNATURE OF QUALITY

SERIES



A Superior Time-Based Trailer Brake Control Featuring Advanced FET Technology and Dual LED Indicators

- Mounts in any Position - No Need for Leveling
- Powerful FET Technology (Field Effect Transistors)
- Supports 2 – 4 Brake Magnets (1 to 2 Axles)
- Dual LED Display is Visible From Any Angle
- EZ Touch Thumb Wheel
- Up- Front Manual Over-Ride Control
- Reverse Polarity Protection
- Short Circuit Protection
- Plug-N-Play Port for OEM Applications
- Detachable Pigtail Harness
- Manual Braking Illuminates Vehicle & Trailer Stop Lamps
- Operates Seamlessly With Electric-Over-Hydraulic Trailer Braking Systems
- Limited Lifetime Warranty

Time-Actuated Trailer Brake Control Featuring Advanced FET Technology and an Easy-To-Read Digital Display

- Mounts in any Position - No Need for Leveling
- Powerful FET Technology (Field Effect Transistor)
- Supports 2 – 8 Brake Magnets (1 to 4 Axles)
- Front Mounted Digital Output Indicator Allows Viewing From Any Angle
- EZ Touch Thumb Wheel
- Up- Front Manual Over-Ride Control
- Overload Indicator
- Active Trailer Disconnect Monitoring Indicator
- Reverse Polarity Protection
- Short Circuit Protection
- Plug-N-Play Port for OEM Applications
- Detachable Pigtail Harness
- Manual Braking Illuminates Vehicle and Trailer Stop Lamps
- Operates Seamlessly with Electric-Over-Hydraulic Trailer Braking Systems
- Limited Lifetime Warranty

PROPORTIONAL CONTROL
 PROPORTIONAL TRAILER BRAKE CONTROL
 FOR 1 TO 4 AXLE TRAILERS

65-75813



GYRO ACCELROMETER
 PROPORTIONAL TRAILER
 BRAKE CONTROL

65-75814



Exclusive Gyro-Accelerometer Technology Provides the Most Advanced Proportional Response in Electronic Trailer Braking

- Universal Mounting: - 0-90 Pitch, -30 to + 30 Roll, -30 to Plus 30 Yaw
- 6-Segment Front Mounted LCD Digital Display
- EZ Touch Thumb Wheel
- Up- Front Manual Over-Ride Control.
- Overload Indicator
- Active Trailer Disconnect Monitoring Indicator
- Reverse Polarity Protection
- Short Circuit Protection
- No Low Amperage Feedback
- Plug-N-Play Port for OEM Applications
- Compatible with Vehicle Electronic Systems, (ABS, Cruise Control)
- Manual Braking Illuminates Vehicle and Trailer Stop Lamps
- Operates Seamlessly with Electric-Over-Hydraulic Trailer Braking Systems
- Limited Lifetime Warranty

Delivers Trailer Braking in Exact Proportions at the Moment You Need It, Utilizing Exclusive Gyro-Accelerometer Technology

- Universal Mounting Array
- Full 360° Awareness - Operates in ANY Direction
- Powerful FET Technology (Field Effect Transistor)
- Supports 2 – 8 Brake Magnets (1 to 8 Axles)
- Advanced 8-Segment Scrolling LCD Digital Display Mounted on a Pivoting/Tilting Screen
- User Memory Settings and Load Level Settings
- Tow Vehicle Battery Volt. & Diagnostic Error Codes
- Overload & Active Disconnect Indicator
- Reverse Polarity and Short Circuit Protection
- No Low Amperage Feedback
- Plug-N-Play Port for OEM Applications
- Manual Braking Illuminates Vehicle and Trailer Stop Lamps
- Compatible with Vehicle Electronic Systems, (ABS, Cruise Control)
- Operates Seamlessly with Electronic-Over-Hydraulic Trailer Braking Systems
- Limited Lifetime Warranty

WIRING HARNESSSES

BRAKE CONTROL

Many vehicles now come equipped with factory brake control wiring. Brake control wiring harness easily connect most brake controls into the tow vehicle's factory wiring harness.

DUAL CONNECTOR

Dual connector harnesses have a vehicle specific connector opposite a 4-pin single row connector designed to plug directly into many popular brake controls.

FEATURES

- Engineered to highest industry standards
- Designed to mate seamlessly with OEM systems
- 12 gauge wire for lasting durability and safety
- Complete comprehensive installation instructions
- 100% copper stranded wire
- For use with all Westin Brake Controllers

DIAGRAM

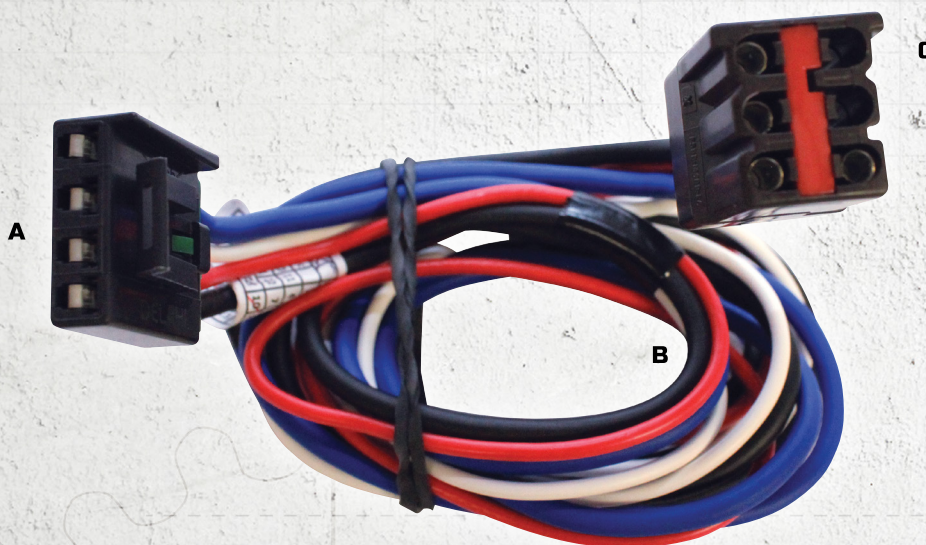

A Single-Row Connector	B 100% copper stranded wire	C OEM grade connector*
-------------------------------	------------------------------------	-------------------------------

*OEM grade connector and terminals, plug directly into tow vehicles factory tow harness

12 GAUGE WIRE	BLACK	12V+
	BLUE	TRAILER BRAKE OUTPUT
16 GAUGE WIRE	RED	STOP LAMP INPUT
	WHITE	GROUND

BREAKAWAY KITS

TRAILER BRAKE PRODUCTS

65-75840

PUSH-TO-TEST BREAKAWAY KIT (TOP LOAD)

- Push-To-Test confirms battery is fully charged, charging or low
- 5 AMP hour battery
- Breakaway switch
- Mounting hardware



65-75023



**REPLACEMENT
5 AMP BATTERY**

65-75028



**BREAKAWAY KIT
W/BATTERY**

65-75005



**REPLACEMENT
BREAKAWAY SWITCH**

BREAKAWAY KITS

WIRING HARNESSES

APPLICATIONS

START	END	MAKE	MODEL	LOCATION	PART #
2008	2016	Buick	Enclave	A	65-75289
2000	2002	Cadillac	Escalade	C	65-75283
2003	2006	Cadillac	Escalade EXT/ESV	C	65-75284
2015	2016	Cadillac	Escalade/Escalade ESV	C	65-75296
2007	2016	Chevy/GMC	Acadia	A	65-75289
2009	2016	Chevy/GMC	Traverse	A	65-75289
2000	2002	Chevy/GMC	Avalanche	C	65-75283
2003	2006	Chevy/GMC	Avalanche	C	65-75284
1999	2002	Chevy/GMC	Silverado/Sierra	C	65-75283
2003	2006	Chevy/GMC	Silverado/Sierra	C	65-75284
2007	2007	Chevy/GMC	Silverado/Sierra Classic - Amber Turn Signal	C	65-75284
2014	2016	Chevy/GMC	Silverado/Sierra 1500	A	65-75296
2015	2016	Chevy/GMC	Silverado/Sierra 2500/3500	A	65-75296
2015	2016	Chevy/GMC	Suburban	C	65-75296
2015	2016	Chevy/GMC	Tahoe	C	65-75296
2000	2002	Chevy/GMC	Suburban / Tahoe	C	65-75283
2003	2006	Chevy/GMC	Suburban / Tahoe	C	65-75284
2015	2016	Chevy/GMC	Yukon/Yukon XL	C	65-75296
2000	2007	Chevy/GMC	Yukon/Denali	C	65-75283
2003	2006	Chevy/GMC	Yukon/Denali	C	65-75284
2011	2014	Dodge	Durango - W / Tow Package	C	65-75294
2013	2014	Dodge/Ram	Ram 1500/2500/3500	B	65-75295
2007	2009	Dodge	Aspen - W / Tow Package	A	65-75281
1997	2011	Dodge	Dakota - W / Tow Package	A	65-75281
1998	2009	Dodge	Durango - W / Tow Package	A	65-75281
1995	2009	Dodge	Ram - W / Tow Package	A	65-75281
2010	2012	Dodge	Ram 1500/2500/3500	C	65-75293
2009	2014	Ford	Econoline	B	65-75290
2013	2014	Ford	Expedition	H	65-75290
2002	2014	Ford	Explorer - W / Tow Package	B	65-75280
2014	2014	Ford	Flex	H	65-75290
2009	2016	Ford	F-150	H	65-75292
2008	2016	Ford	F-250/550	H	65-75290
1992	1993	Ford	F-Series	B	65-75070
1992	1993	Ford	Bronco	B	65-75070
1994	1996	Ford	Bronco	B	65-75280
1992	2008	Ford	Econoline	B	65-75280
2000	2005	Ford	Excursion	B	65-75280
1997	2012	Ford	Expedition	B	65-75280
2012	2013	Ford	Flex	H	65-75292
2009	2011	Ford	Flex	H	65-75280
2004	2004	Ford	F-150 - Heritage Edition	B	65-75280
2004	2008	Ford	F-150 - New Body Style	B	65-75280
1997	2003	Ford	F-150/250 LD	B	65-75280
1994	1996	Ford	F-150/350	B	65-75280
1999	2004	Ford	F-250/350	B	65-75280
2005	2007	Ford	F-250/350	B	65-75287
2005	2007	Ford	F-450/550	B	65-75287
1995	2003	Ford	Windstar - W / Tow Package	B	65-75280
2009	2016	Honda	Pilot	A	65-75288

START	END	MAKE	MODEL	LOCATION	PART #
2006	2014	Honda	Ridgeline - W / Tow Package	A	65-75288
2003	2007	Hummer	H2	C	65-75284
2011	2013	Jeep	Grand Cherokee	C	65-75294
2009	2011	Kia	Borrego	G	65-75291
2005	2014	Land Rover	Rover	B	65-75280
2005	2009	Land Rover	LR-3	B	65-75280
2010	2014	Lexus	GX 460	C	65-75285
2003	2009	Lexus	GX 470	C	65-75285
2003	2007	Lexus	LX 470	C	65-75285
2008	2010	Lexus	LX 570	C	65-75285
2012	2015	Lincoln	MKT	B	65-75292
2006	2008	Lincoln	Mark LT	B	65-75280
2010	2011	Lincoln	MKT	B	65-75280
1998	2011	Lincoln	Navigator	B	65-75280
2002	2010	Mercury	Mountaineer - W / Tow Package	B	65-75280
2004	2014	Nissan	Titan / Armada	E	65-75286
2005	2014	Nissan	Pathfinder / Frontier	E	65-75286
2007	2009	Saturn	Outlook	A	65-75289
2003	2014	Toyota	4Runner / Sequoia / Tundra	G	65-75285
2007	2014	Toyota	Tacoma	G	65-75285

FACTORY BRAKE CONTROL HARNESS LOCATIONS



A	Under dash, near emergency brake pedal
B	Under dash, right of steering column
C	Under dash, left of steering column
D	Under dash, right side of center console
E	Under dash, left side of center console
F	Under dash, passenger side
G	Kick panel pocket, driver's side
H	Under dash, behind center console

TOW ACCESSORIES

TRAILER BALLS, COUPLERS, BALL MOUNTS AND MORE...

TRAILER BALLS

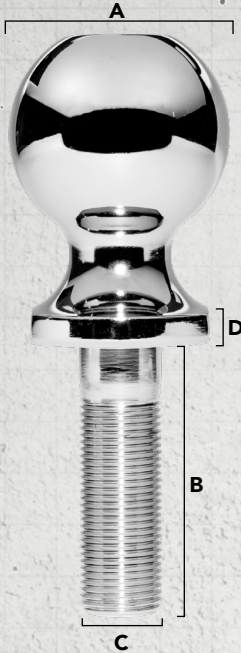

A: BALL DIAMETER

B: SHANK LENGTH

C: SHANK DIAMETER

D: SHANK RISE

TORQUE SPECS

SHANK DIAMETER	TORQUE SPECS
3/4"	160 ft. lbs.
1"	250 ft. lbs.

- Available in 3 ball sizes, 4 shank lengths and 2 shank diameters
- Weight capacity range: 2,000 – 7,500 lbs.
- Chrome finish
- Nut and washer included
- Limited lifetime warranty



PART #	BALL DIAMETER (A)	SHANK LENGTH (B)	SHANK DIAMETER (C)	SHANK RISE (D)	BALL CAPACITY
65-91000	1 7/8"	1 5/8"	3/4"	5/16"	2,000 lbs.
65-91001	1 7/8"	2 1/8"	3/4"	5/16"	2,000 lbs.
65-91002	1 7/8"	3"	3/4"	5/16"	2,000 lbs.
65-91003	1 7/8"	2 1/8"	1"	5/16"	3,500 lbs.
65-91004	2"	1 3/4"	3/4"	5/16"	3,500 lbs.
65-91005	2"	2 1/8"	3/4"	5/16"	3,500 lbs.
65-91006	2"	3"	3/4"	5/16"	3,500 lbs.
65-91007	2"	2 1/8"	1"	5/16"	6,000 lbs.
65-91008	2 5/16"	2 1/8"	1"	5/16"	7,500 lbs.

NUT & WASHER



- Durable zinc finish
- Available in two sizes (3/4" & 1")
- Limited lifetime warranty



PART #	DESCRIPTION
65-91009	3/4" replacement nut & lock washer
65-91010	1" replacement nut & lock washer

PIN & CLIP



- For securing ball mounts to receiver hitches
- Available in two sizes (1/2" & 5/8")
- Zinc Finish
- Limited lifetime warranty



PART #	FINISH	DESCRIPTION
65-691100	Zinc	1/2" hitch pin with clip
65-691101	Zinc	5/8" hitch pin with clip

SAFETY CHAIN



- Secures the trailer to tow vehicle in case of hitch disconnect
- Includes (2) S-hooks
- Available in two sizes (3/16" x 41" & 1/4" x 40")
- 48" in length
- Limited lifetime warranty



PART #	MIN. BREAK FORCE	CHAIN	LENGTH	DESCRIPTION
65-691102	2,000 lbs.	3/16" x 41"	48"	Includes (2) 3/8" S-hooks
65-691103	5,000 lbs.	1/4" x 40"	48"	Includes (2) 7/16" S-hooks

COUPLERS



- Durable zinc finish
- Lockable latch
- Available in 1 7/8" Balls (2" or 2 1/2" channel)
- Available in 2" Balls (2 1/2" or 3" channel)
- Limited lifetime warranty



PART #	TW/GTW	DESCRIPTION
65-691200	200/2,000 lbs.	1 7/8" ball, 2" channel
65-691201	200/2,000 lbs.	1 7/8" ball, 2 1/2" channel
65-691202	350/3,500 lbs.	2" ball, 2 1/2" channel
65-691203	500/5,000 lbs.	2" ball, 3" channel

TOW ACCESSORIES

RECEIVER TUBE ADAPTERS, MULTI-BALL MOUNTS AND MORE...

RECEIVER TUBE ADAPTERS



- Adapts receiver tube from 1 1/4" to 2"
- 6 1/4 in length
- Black powder coat finish
- 3 year warranty

PART #	ADAPTS FROM	ADAPTS TO	LENGTH	TW/GTW
65-691302	1 1/4"	2"	6 1/4"	350 lbs. / Not for towing use

RECEIVER TUBE EXTENDED



- Extends receiver tube providing additional clearance
- Shank size 1 1/4" extends 7"
- Shank size 2" extends 8"
- Black powder coat finish
- 3 year warranty

PART #	SHANK SIZE	EXTENDS	TW/GTW
65-691300	1 1/4"	7"	350 lbs. / Not for towing use
65-691301	2"	8"	350/3,500 lbs.

MULTI-BALL MOUNT



- Fully welded trailer balls
- Powder coat finish
- Includes 1 7/8", 2" and 2 5/16" ball sizes
- Length varies depending on ball size position
- 3 year warranty

PART #	SHANK	BALL COLOR	LENGTH	TW/GTW BALL SIZE - 1 7/8"	TW/GTW BALL SIZE - 2"	TW/GTW BALL SIZE - 2 5/16"
65-691303	Solid	Chrome	6 3/4" & 8"	500/5,000 lbs.	750/7,500 lbs.	1,000/10,000 lbs.

BALL MOUNT KITS



- Chrome ball with black draw bar
- Pin and clip included
- Complete with trailer ball
- 3 year warranty

PART #	DROP	LENGTH	TW/GTW	BALL SIZE
65-691304	2"	8 1/4"	350/3,500 lbs.	1 7/8"
65-691305	2"	8 1/4"	750/7,500 lbs.	2"
65-691306	4"	8 1/4"	350/3,500 lbs.	1 7/8"
65-691307	4"	8 1/4"	750/7,500 lbs.	2"

BALL MOUNTS



CLASS I BALL MOUNTS

- Available in 3 drop sizes
- Black powder coat finish
- 3 year warranty

CLASS III BALL MOUNTS

- Available in 5 drop sizes
- Black powder coat finish
- 3 year warranty

CLASS I BALL MOUNTS

PART #	DROP	RISE	LENGTH	TW/GTW
65-691320	1 1/4"	3/4"	6 3/4"	350/3,500 lbs.
65-691321	2 3/4"	1 1/8"	7 1/2"	350/3,500 lbs.
65-691322	3 1/4"	2 5/8"	7 1/4"	350/3,500 lbs.

CLASS III BALL MOUNTS

PART #	DROP	RISE	LENGTH	TW/GTW
65-691308	2"	3/4"	8 1/4"	750/7,500 lbs.
65-691309	4"	2 3/4"	8 1/4"	750/7,500 lbs.
65-691310	6"	4 3/4"	9 1/4"	750/7,500 lbs. drop / 600/6,000 lbs. rise
65-691311	8"	6 3/4"	11 1/2"	500/5,000 lbs. drop / 350/3,500 lbs. rise
65-691312	10"	8 3/4"	13"	500/5,000 lbs. drop / 350/3,500 lbs. rise

RETAIL

MARKETING SUPPORT

RECEIVER HITCH DISPLAY

55655



HITCHES NOT INCLUDED

RECEIVER HITCH DISPLAY INCLUDES:
WESTIN TOWING HEADER CARD, GRID AND STAND

WESTIN TOWING HEADER CARD

WESTIN® TOWING

RECEIVER HITCHES // ELECTRICAL // ACCESSORIES
THE POWER TO TOW WHEREVER YOU WANT TO GO

E-COATED STEEL

TEXTURED BLACK POWDER COAT

THROUGH BRACKET CONSTRUCTION

WELDED CARPED TUBES FOR A FINISHED LOOK

DOUBLE SIDED WELDS

STYLIZED FORGED STEEL COLLAR

UNIQUE DELTA CUT SAFETY CHAIN LOOP

T-CONNECTORS, ADAPTERS & MORE

TRAILER BALLS & MOUNTS

BRAKE CONTROLS

ACCESSORIES & MORE

PATENT PENDING

3 YEAR LIMITED WARRANTY

LIFETIME WARRANTY

800.345.8476 | WESTINAUTOMOTIVE.COM

PLEASE SEE YOUR WESTIN SALES EXPERT FOR MORE INFORMATION

SEARCH "WESTIN" AND STAY CONNECTED

Facebook, Twitter, YouTube, Instagram, LinkedIn, Pinterest, RSS, QR Code

RETAIL DISPLAY

GLOSSARY

OF TERMS

RECEIVER HITCHES TERMS

RECEIVER HITCH - A device that attaches directly to a tow vehicle providing a connection between the tow vehicle and a trailer. It has a receptacle (typically 1-1/4" or 2" square) used to mount different styles of mounts or hooks.

RECEIVER - The receptacle part of a trailer hitch which accommodates inserts such as ball mounts, drawbars or accessory carriers. Common receiver sizes are 1-1/4" and 2".

DRAW BAR - A removable coupling. It fastens to a receiver hitch receptacle with a "hitch pin" (usually 1/2" or 5/8" diameter). It allows the mounting of hitch balls, pintles, or hooks.

BALL MOUNT - A type of draw bar mount that can be inserted into a receiver hitch receptacle. It allows the installation of trailer balls of different sizes. This allows the ball and ball mount assembly to be easily removed when not in use.

HITCH BALL - A ball shaped attachment to a ball mount or directly to a hitch onto which a trailer coupler is attached.

HITCH PIN - Used to fasten any receiver hitch insert or draw bar into a receiver hitch.

LOCKING HITCH PIN - A hitch pin that has the ability to lock the draw bar or hitch insert to prevent theft.

CLASS I TRAILER HITCH - Trailer hitch with capacity of up to 3,500 lbs gross trailer weight and 350 lbs tongue weight.

CLASS III TRAILER HITCH - Trailer hitch with weight carrying rating of up to 10,000 lbs gross trailer weight and 1,000 lbs tongue weight.

GOOSENECK - A Class 5 hitch that mounts a ball in the bed of a pickup truck (either 2-5/16" or 3" in diameter) to engage a coupler on a trailer. Not to be confused with a fifth wheel.

SWAY CONTROL DEVICE - A device similar to a shock absorber which resists swaying movement of a trailer tongue sometimes caused by passing vehicles and wind.

SAE J684 - This is the current Society of Automotive Engineers specification for towing products & accessories. This is the testing specification Westin receiver hitches are tested for.

V-5 - A testing specification from the Vehicle Equipment Safety Commission. Although this is still advertised, it is superseded by SAE J684.

TRAILER WEIGHT - The term to describe the total weight of the trailer including tongue weight.

TONGUE WEIGHT - The term to describe the weight capacity that is placed directly on the hitch ball/hook. This is the amount of load actually placed on the vehicle.

FAMILY OF BRANDS

WESTIN

T-MAX

FEY

Wade

BAUTEJ

HDX

SNYPER
PRECISION TECHNOLOGY

WESTIN AUTOMOTIVE PRODUCTS, INC
320 W. COVINA BLVD.
SAN DIMAS, CA 91773

WESTIN SALES / MARKETING
PH: 626. 960. 6762
FAX: 626. 960. 2055
WWW.WESTINAUTOMOTIVE.COM
EMAIL: INFO@WESTINAUTOMOTIVE.COM

CUSTOMER SERVICE
PH: 800. 345. 8476
FAX: 626. 813. 4890
EMAIL: CUSTOMERSERVICE@WESTINAUTOMOTIVE.COM
7 AM - 4 PM PST



DISTRIBUTED BY:

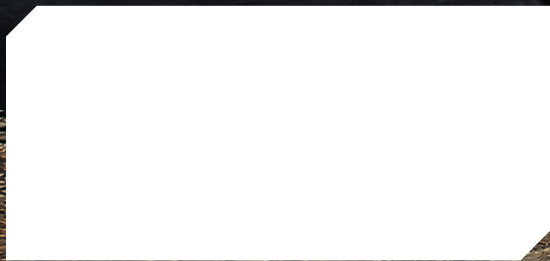

SEARCH "WESTINAUTO"
AND STAY CONNECTED



2016 TOWING CATALOG

